

# 924·924 TURBO

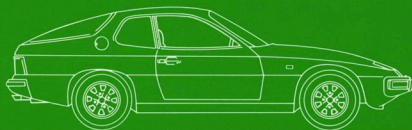

# A conviction born of necessity.

Like the drivers they serve, automobiles have forever left behind a simpler age when the freedom, endowed by individual mobility, could be blithely taken for granted.

The importance of the automobile to our late Twentieth Century lifestyle is, if anything, more central than ever before. But its importance is widely underestimated.

Few people who use their cars as part of their daily routine place a proper value on the unique independence their vehicles afford them.

Perhaps simply because cars have always been readily available.

Today, this availability can no longer be taken for granted. Fuel rationing may be merely the tip of the iceberg. Imagine rationing of the automobile itself!

It is only through comprehension of what it would be like to do without this key ingredient in our lifestyle that we can fully understand the dimensions of our potential loss.

The future of the automobile will be decisively shaped by our preconceptions. Our attitude towards this tool should not take the form of resignation in the face of "overwhelming" external forces.

Instead we must adapt and re-shape. Meet changing conditions with new solutions. And change the conditions themselves, wherever possible, so that we need not experience them as obstacles.

Porsche's consciousness of these changing relationships is a dynamic factor in the evolution of the new generation of Porsches. And at the same time, this consciousness can form the basis for the realistic way in which Porsche drivers use the cars that are carrying them into the future.

**Table of Contents**

The body: As advanced as the transaxle itself.	4-7
Interior: Relaxing for daily use.	8-13
Engine: A powerful two-liter power plant.	14-15
Chassis: New methods for new models.	16-17
Power transmission: Straight-line transfer.	18-19



Brakes, steering: A close relationship within the Porsche family.	20–21
Research in the countryside: The Weissach team.	22–25
Safety: A complete system.	26–27
Manufacturing: Swabian thoroughness.	28–29
Value retention: Use without regrets.	30–31
Technical data, standard equipment and options.	32–33



# The body:

## As advanced as the transaxle itself.

Outstanding driving performance and handling, combined with reliability, define the most traditional of all Porsche values: To these, the 924 adds an exacting standard of value in daily use.

If we measure automotive engineering advances in terms of gains in fuel economy, then the first model of the Porsche transaxle generation is undoubtedly a winner. With 100,000 cars built, the 924 and 924 Turbo clearly show that a sports-car body, designed on strict aerodynamic principles, is one of the best solutions automakers have come up with to meet the problem of achieving fuel economy "without sacrificing performance."

Thus the 924 series takes its rightful place beside a galaxy of Porsche vehicles that have long stood out from the pack. Nor is this situation likely to change in the foreseeable future.

The primary function of the over-engineered car is to provide good daily transportation at a relatively low cost. Porsche, on the other hand, sees itself in a new, future-oriented mode: providing high performance, yet efficient cars, for those drivers who do not require the spaciousness of a sedan.

This basic Porsche concept offers advantages which are difficult, if not impossible to obtain in less aerodynamic vehicles. Compact, low-slung Porsche designs reduce weight and drag. Light-weightly construction, used more systematically by Porsche than by many other manufacturers, offers additional advantages. And Porsche's choice of rugged, durable materials ensures a high degree of reliability and long life.

1982 EPA estimates: 924—20 estimated mpg, 35 estimated highway mpg (manual), 924 Turbo—20 estimated mpg, 33 estimated highway mpg. Use "estimated mpg" for comparison. Your mileage may vary with weather, speed, and trip length. Actual highway mileage will probably be less.

## A well-defined goal for a well-defined shape.

An automobile manufacturer of Porsche's caliber must make a clear distinction between mere whims of fashion and the demands of aerodynamics. Porsche cannot adjust its design concepts to unproven theories seeking to redefine the ideal form. But it must take seriously all those factors affecting automobile construction that have established a long-term value: demands for greater safety, better energy utilization, quieter operation, cleaner exhaust, longer life.

Demands for power and comfort are simultaneously increasing rather than declining. This simply underscores the fact that the more we become aware of the value of energy, the more important becomes the quality of its utilization.

Performance, including active safety, thus takes on new significance. And for Porsche, this new attitude confirms a concept we have long applied: building fuel-efficient vehicles through the application of proven aerodynamic principles and the reduction of weight to the lowest level consistent with safety and durability.

## Characteristics of a model.

The characteristics of a body with good aerodynamic properties are low air resistance, controlled high operating speed, good road-holding, and low sensitivity to crosswinds. Most of these characteristics can be measured and improvements made using a scale model in the wind tunnel.

Porsche tests body designs and major modifications at an early stage with the aid of extremely detailed 1:5 scale models. Later, the optimum design of the details is determined on full-scale drivable prototypes in a large wind tunnel.

## Systematic body design.

More than any other kind of car, a sports car depends for its success on the design of its outer skin. If a convincing synthesis of handling, safety, and fuel economy is to be achieved, form becomes a key factor.

Porsche's 4-cylinder series owes its undisputed success in large measure to the purity of its body styling. This is

http://coochas.com  
dynamic properties. The classic lines of the 924 and 924 Turbo are not determined by fashion or styling. Instead, form follows function in the creation of truly outstanding sports cars.

The styling of Porsche 924 appeals to those to whom driving is an intense experience. And to enthusiasts who see a sports car, not as a symbol or pretention, but as a means to individualistic mobility, safety, and rational economy.

Clearly defined lines, instead of sharp contours, characterize Porsche 924. Gently rounded surfaces in place of energy-consuming rectangular forms are the hallmarks of this unique Porsche design. The body of the 924 is technically superb, physically logical and formally complete.

Like its sisters, the 924 clearly meets one of the most important prerequisites for Porsche's deliberate policy of model consistency: preserving the value of its automobiles through the use of styling that withstands the test of time.

## 924 and 924 Turbo.

In its 4-cylinder series, Porsche's response to demands for higher performance is the 924 Turbo, with its 154 hp and top speed of 134 mph. The normally aspirated version, with 110 hp, reaches its top speed at 120 mph. Both vehicles have engines with a 1984 cc displacement.

Like other Porsches, the 924 series masks its speed beneath a quietly graceful exterior. Yet 924 Turbo is one of the fastest production two-liter cars in the world.

Noticeable differences between it and the 924 are limited to but a few modifications. All of these serve a specific purpose related to the turbo-charged engine, high-speed handling characteristics or aerodynamics.

## The way the wind blows: Porsche aerodynamics.

Air resistance is a function of the front surface of a vehicle. Particularly in a sports car designed for speed, air resistance must be minimized to ensure low fuel consumption and high speed. A mere doubling of speed brings with it an eightfold increase in engine output required to overcome air and rolling resistance. Thus, work performed by Porsche engineers in the wind tunnel is aimed at progress that benefits everyone.

The Porsche 924 series is distinguished by low drag coefficients: a Cw of 0.36 for Porsche 924, and for 924 Turbo, a Cw of 0.34.

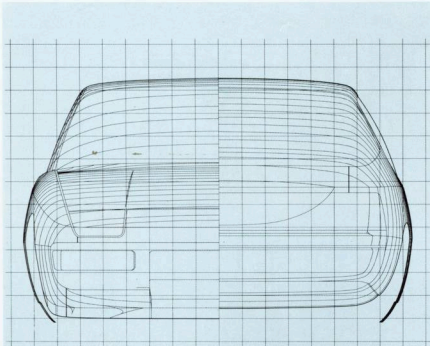

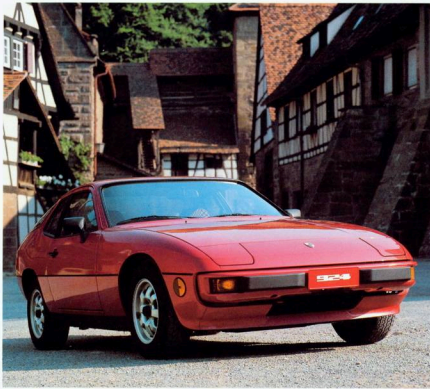

**Porsche roof carriers.**

There is nothing new about using the space atop a vehicle for "excess baggage." Porsche has a sturdy system for this purpose. Depending on the object to be transported, two basic supports carry various auxiliary devices:

- Ski holder
- Ski box
- Luggage rack
- Surfboard holder

- Boat carrier
- Bicycle holder
- Luggage box

All components of the roof transport system are designed for high stability and low air resistance. This system ensures controlled driving performance even if the 165 lb. maximum roof load is carried as part of the permissible total weight. A lockable carrier base provides a measure of protection against theft.



Specifications, standard equipment and options are subject to change without notice.



### Body design and handling characteristics.

Equally important is the close relationship between body design and handling characteristics. Under normal weather conditions, handling is greatly influenced by aerodynamic lift. Since lift forces increase with the square of the velocity, handling characteristics may change dramatically at high speeds. The car's ability to hold the road, its braking performance, and its capability for

way that lift did not reduce its road holding ability.

The Porsche 924 was refined to behave well in crosswinds while it was still just a small-scale model in the wind tunnel. By lifting the rear end, the slip stream's point of attack was moved to a favorable position. Vehicle reaction to crosswind is decisively affected by the distance between this point and the car's center of gravity. So the transaxle 924—like the 928—is highly unlikely to be affected by crosswind

for ventilating the passenger compartment. These measurements are also used in computing the air pressure exerted on individual components, such as doors, windows and hood, and to eliminate wind noise through appropriate design.

Analysis shows high and low pressure zones on a longitudinal section of Porsche 924. A great difference in pressure between the cool-air inlet and the bottom of the engine compartment is clearly indicated. Because of this pressure differential, air flow through the radiator is so strong that the electric auxiliary blower is switched on only when the thermal loads on the engine are extremely high.

The passenger compartment is ventilated via an air inlet located in the high-pressure zone in front of the windshield. Air exits from the interior through a gap, not visible from the outside, between the front fenders and the door.

Short woolen threads are glued to the car in a grid pattern as an aid in



executing difficult maneuvers will all change with increases in speed.

In the past this was a major problem in the design of racing cars. To solve it, Porsche conducted extensive wind tunnel tests with a variety of body designs. The results of this testing helped give street Porsches their outstanding handling characteristics. Thus, Porsche 924 is equipped with a standard front spoiler. And when the body of the 924 was first designed, the basic shell was conceived in such a

because the center of gravity is located near the mid-point of the car.

### Air where it is needed.

The air stream creates zones with different air pressures on the body surface. Air pressure, and its distribution on the external body surface, are measured in the wind tunnel with pressure sensors. This enables Porsche engineers to determine the optimum location and size of air intakes for cooling the engine and the brake system, and

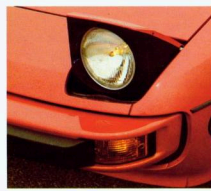

investigating flow lines on the body. When exposed to a stream of air in the wind tunnel the threads lie parallel to the air flow. Among other things, this indicates to what extent dirt thrown up by the front wheels will settle on the sides of the body. The wind tunnel study shown in the picture illustrates how "clean" air compressed in front of the windshield flows laterally over the fenders of the 924 towards the rear. Dirt churned up by the front wheels is pushed down by this flow pattern. As a

result, comparatively little dirt settles on the upper halves of the side panels and doors, including the area where door handles and locks are mounted. The rear lights, too, are reached, in part, by this "clean" air stream. The rear bumper, located just above, provides additional protection required to help keep the lights free of dirt.

Recessed rain channels help prevent the side windows from being soiled by water running off sideways from the windshield. The channels are mounted on the "A"-pillars, or front roof posts, and are designed to protect the outer windshield frame without increasing noise generated by the air flow. This elegant solution greatly reduces the deposit of dirt which would otherwise interfere with the driver's vision.

**Contoured for performance.**

The most important body modifications of the 924 Turbo are related to its exceptional power and performance. The car is fitted with larger, 15-inch light alloy wheels to provide space for the installation of larger, internally ventilated disc brakes that provide greater high-speed stopping power.

Slots in the left and right sides of the front spoiler supply ventilation for the front brakes and oil cooler. Additional air intakes between the main headlamps, together with a NACA vent on the exhaust and turbocharger side of the engine hood, help meet the engine's stepped-up need for cool air and provide effective evacuation of heated air from the compartment.

On the Turbo, the narrow polyurethane rear spoiler increases negative lift at high speeds. This increases traction of the driving wheels and improves directional control.

**A system for sight.**

At night on excellent view of the road ahead is provided by high-intensity halogen headlamps. The headlamps are harmoniously recessed into the front section of the body. They provide the low and high beams and are moved into place by an electric motor. Optional headlamp washing system ensures optimum light at all times. When activated, a pump supplies a high-pressure stream of wash water via nozzles in front of the retractable headlamps.

Large multiple-chamber lights in the rear provide good illumination for the back of the car. Amber combination safety flasher/turn-signal lights and back-up lights are standard equipment.



The outside rearview mirrors, located on both the driver's and the passenger's side, are electrically adjusted from inside the car. The mirrors can also be heated to prevent build-up of mist or ice.

Wipers, defoggers and defrosters help ensure an unimpeded view through the laminated glass windshield. An electric defroster for the curved safety-glass rear window is standard equipment. During bad weather, rear vision is improved by an optional rear-window wiper.

**A finish that simultaneously dazzles and protects.**

The extraordinary quality of the paint finish of Porsche 924 accounts in large measure for both the elegant aesthetics of the car and the longevity of its resale value.

Thanks to thorough corrosion protection, the striking appearance of the exterior can be expected to last for many years.

Porsche builds its bodies for long life and hard use. The bottom and upper parts of the self-supporting structure are steel sheets that have been galvanized on both sides. The front skirt, bumpers, and protective side ribs are made of resilient, impact-resistant plastic.

Seven standard colors, seven metallic colors, and three two-tone finishes are offered for Porsche 924 and 924 Turbo.

The 924's pressure-cast light alloy wheels, size 6 J x 14 (6 J x 15 pres-

sure-cast alloy spoke wheels with turned, polished front surfaces are available as an option), and the 5-bolt 15-inch spoked wheels of the 924 Turbo (forged 6 J x 16 alloy wheels are available as an option) are all protected against corrosion. Black, protective, weather-proof plastic side moldings—the material also used in the 924 Turbo for the additional rocker panels—help prevent damage from carelessly opened doors.

An optional removable roof panel, available in the 924 and 924 Turbo, provides magnificent views of the sky. The panel is painted the same color as the car and can be carried in the trunk, stored in a protective bag. A wind deflector pops up automatically when the panel is removed, reducing annoying turbulence. The rear end of the panel can also be raised. When this is done, wind passing across the roof makes little noise and produces hardly any draft, even at high speeds.



Specifications, standard equipment and options are subject to change without notice.





## Interior:

### Relaxing for daily use.

A car that conserves fuel\* as efficiently as Porsche 924 might well be expected to conserve the driver's energy, too. Reliable operation of sophisticated, high-performance sports-car equipment requires that it be easy to handle.

On the basis of long experiences in sports-car building, together with ongoing research at Weissach, Porsche has developed a system for the automobile interior in which

operating safety and driving comfort complement one another. The thoroughness with which this concept comes to life in the 924 and 924 Turbo ensures optimum conditions for self-confident, safe driving.

### The interface between man and the machine.

In Porsche 924, operating safety begins with a clear field of vision for the driver—to the front, the sides, and the rear. Unusually slim front roof

posts, which owe their high strength to internal reinforcements, and carefully designed cross sections minimize obstacles to visibility.

An excellent view of the interior and outside rearview mirrors, the instruments and the operating controls helps the driver of this sports car take in the overall situation at a glance. The steering wheel and the instrument cluster have been placed so that vision through the windshield is unimpeded.

Easily adjustable seats, with pro-

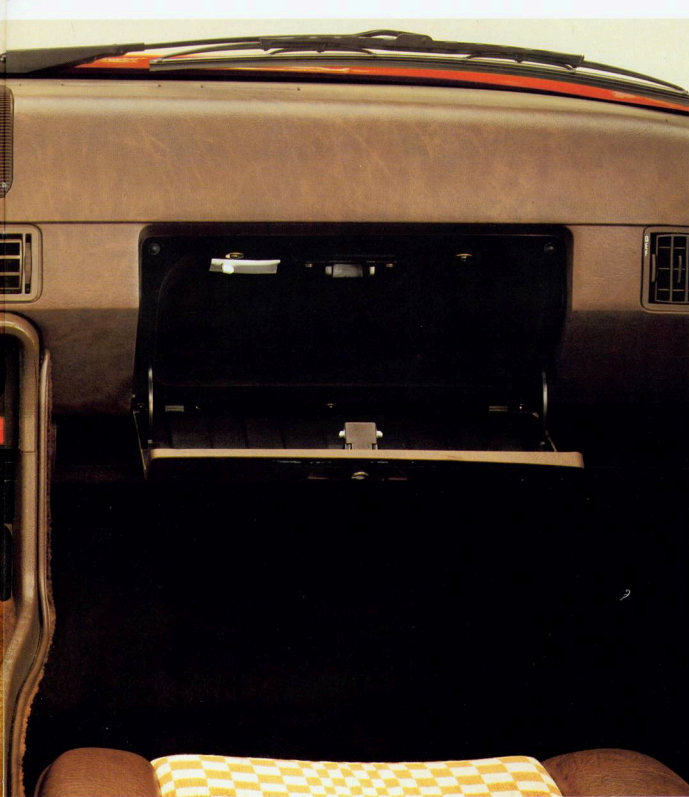

The cockpit and operating systems of the 924 are designed to Porsche standards. All switches, controls and levers on the steering column, the instrument cluster, and the center console are within easy reach. Their logical design and placement let the driver give his undivided attention to the traffic.

Indicators for the most important operating functions are included in the instrument cluster, in the driver's primary field of vision. In all positions of the steering wheel and the seat, the no-glare dials remain comfortably visible. Red pointers against black scale backgrounds and clearly divided spaces make it easy to read off information. Instrumentation illumination is continuously adjustable to compensate for ambient lighting conditions.

In addition to the speedometer, tachometer, temperature and fuel gauges, the 924 and 924 Turbo are equipped with a quartz crystal chronometer, an oil pressure gauge, and a voltmeter. All three are located in full view on a vertical panel of the center console.

The two outside mirrors are equipped with electric motors operated through a control switch recessed in the upholstery of the driver's door. A selector switch on the center console determines whether the switch operates the driver's or the passenger's mirror. When the rear-window defroster is turned on, the outside mirrors are also electrically heated to keep them free of ice and condensation.

The interior mirror is bonded directly to the windshield. Its narrow base helps prevent disturbing oscillations and leaves the driver with an obstacle-free view.

Porsche 924 and 924 Turbo are equipped with power windows. A second switch in the driver's door makes it possible to activate the window in the passenger door from the driver's side.

In addition to the wiper-washer system for the windshield, a high-pressure headlamp washing system is available as an option for both models. The system draws upon a 1.5 gallon tank that also supplies the windshield washing system. When a rocker switch on the center console is depressed, a separate pump sends a high-pressure stream of wash water to nozzles in front of the headlamps. An adjacent rocker switch activates the optional rear-window wiper.

jecting bolsters, support the driver in the optimum position for steering, pedal operation, and sight, regardless of body size. Together with the great number of devices in the Porsche that help the driver keep at peak efficiency, this helps turn secure handling of powerful sports-car technology into relaxed driving.

The positioning and mode of operation of the pedals is based on the most recent knowledge gained from ergonomic studies and Porsche's

racing experience. Low pedal force and cohesion permit sensitive clutching and braking. Perfect coordination of pedal position and force vectors help prevent the driver from growing tired when the pedals must be used over long periods, such as in city traffic.

\*1982 EPA estimates:  estimated mpg, 35 estimated highway mpg (manual). Use "estimated mpg" for comparison. Your mileage may vary with weather, speed, and trip length. Actual highway mileage will probably be less.

Specifications, standard equipment and options are subject to change without notice.



### Theft made difficult.

As an option, Porsche 924 can be equipped with an electronic alarm system. Switched on by means of a central switch-lock next to the lock in the driver's door, the system not only monitors the side doors, the hatch cover and the front hood, but also cuts out the starter.

### The Porsche principle: monitored action.

Part of the pleasure of driving a Porsche is the never-failing fascination of experiencing a system prepared for sports-car mobility.

Everything is ideally located: the sporty, 3-spoke, 15-inch diameter, upright steering wheel, the short-throw shift lever for the 5-speed transmission or the smooth-operating selector for the three-speed automatic transmission.

For safety, the steering wheel of the Porsche 924 has a large impact plate. The rim, spokes, and impact plate are padded with foam and designed for secure handling. The wheel is coordinated with the seat position and pedal force requirements. And the rack and pinion steering system is sure and precise. Handling is effortless, at high speeds, in tight curves, and when maneuvering and parking.

A smaller 4-spoke leather-covered steering wheel, 14½ inches in diam-

eter, can be ordered as an option for either model. A special horn, first introduced on 924 Turbo, is now standard equipment on both vehicles. Both cars also feature new, easy-to-handle activators on the steering column.

### Division of labor: automatic transmission for the 924.

The first step in lowering energy consumption is to apply power along the path of maximum effectiveness. This is as true for the driver as it is for



the vehicle itself. Automation of the shifting process is of great assistance here.\*

The optional 3-speed automatic transmission for the Porsche 924 is an integral part of the drive train. Selection of the gear ratio most desirable at any given time has been tuned precisely to the torque curve of the engine. Shift points up and down have been carefully selected to retain Porsche's sporty performance efficiency.

\*1982 EPA estimates; ② estimated mpg, 28 estimated highway mpg. Use "estimated mpg" for comparison. Your mileage may vary with weather, speed, and trip length. Actual highway mileage will probably be less.

Specifications, standard equipment and options are subject to change without notice.

### **Inside Porsche 924: a refreshing atmosphere.**

Every system in Porsche 924 is geared to helping the driver operate at peak performance. This concept is furthered by a powerful heating and ventilating system.

The layout of the air distribution system provides fresh-air zones without creating drafts near the passengers' heads. Quick temperature adjustments are achieved by mixing warm and cold air, helping to make

interior temperature comfortable. The high interior driving speed, a feature particularly important in fast sports cars.

The heating system rapidly delivers air at the desired temperature. Warm air can be directed into the leg well and/or upward to keep the front and side windows free of ice and condensation.

Additional outlets are included to direct a steady stream of air on the driver and passenger. Deflectors and flow regulators permit an individual adjustment by each occupant. The blower, which permits both systems to operate at maximum efficiency, runs very slowly whenever the ignition is turned on, ensuring a continuous exchange of air inside the car.

Air conditioning and tinted safety glass all around are standard on both the Turbo and the normally aspirated 924. The system is integrated with the fresh-air system and permits mixing of cooled and preheated air.

Air to be cooled is drawn from the passenger compartment and conducted over evaporator coils that remove heat and moisture. The cooled air then flows through the side vents and the center console grille into the interior of the car. \*

Depending on inside or outside temperature, the air-conditioning system can thus perform a variety of tasks: in hot weather, it cools the interior; in damp, cold weather, it dries the air, preventing condensation from forming on the windshield and side windows. A dual-control knob on the center console regulates the temperature of the incoming air and the speed of the adjustable blower.

### **Noise reduction in the 924.**

Without great fanfare, Porsche 924 has achieved its reputation as a sports car in which high performance is combined with quiet driving. The drive train—engine/transaxle—has been carefully insulated against vibrations. For this purpose, comprehensive tests were conducted to pinpoint the ideal bearing points and select the best bearing elements. The goal was effective damping with low residual vibration.

The gearshift is a good example of the thoroughness of Porsche problem solving. Transmission vibrations to the car body is prevented by fastening the shift lever to the strong transaxle support tube. Two small rubber bearings provide effective insulation between the intermediate shift lever and the shifting head.

Damping of the body is supplemented by a molded part made of flexible polyurethane foam and a

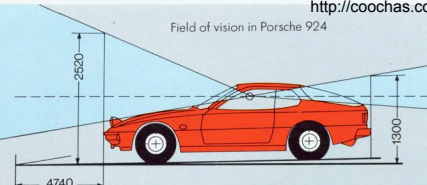

sleeve that extends to the shiftnob with its insulating fastening. The result is an outstanding barrier against vibration and airborne noise.

An extensive insulation and damping system absorbs high-frequency airborne engine noise, halts heat transfer, damps vibrating sheet metal surfaces, and shields the interior from traffic sounds. The noise-reduction package, formerly an option on the 924 Turbo, is now standard equipment on

both. The average decrease in noise is 2 dB (A). Improved door and window seals further reduce wind noise at high driving speeds.

### Entertainment and information inside Porsche 924.

All arrangements have been made to satisfy the high listening demands of Porsche 924 owners. Two stereo speakers in the rear and an additional one on the dashboard, as

well as a fader and an antenna with an interference eliminator are provided as standard equipment. A power antenna is also available as an option.

A digital radio with cassette player is available. Six frequencies can be stored in the memory and tuned in by pressing pushbuttons. An electronic search sweeper operates up and down the dial. The selected frequency appears on a digital display that also shows the time.

### A car that fits the driver.

Comfortable seating is of paramount importance in any high-performance sports car. In Porsche 924, front bucket seats are designed to provide an ideal sitting position and proper posture. The anatomically correct design of the seats and their upholstery ensure relaxed traveling on long trips and excellent support in turns during high-performance driving.

As in all Porsches, the spring sys-



tem of the 924 seats and the vehicle itself, as well as the transverse stabilization and damping of the chassis, form a carefully tuned functional whole.

**Interior elegance.**

An important factor in creating the ambience inside Porsche 924 is the exceptional quality of its materials and the old-world craftsmanship used to execute every detail. Doors and side panels, as well as the center strips and integrated headrests of the Porsche seats, are upholstered in luxurious materials.

Three designs, each in two colors, are available: pinstrips, checked velour and Berber cloth. Leather sport seats are available as an option for both models.

Carpeting is available in three colors, each selected to harmonize perfectly with the matching interior. This carpeting is also used on the center console. In the 924 Turbo, black door sills with white Turbo lettering protect the paint when passengers get in and out. Plastic sheathing protects the step-in area down to the bottom edge of the car.

The parking-brake lever is within easy reach at the driver's left. Front seatbacks fold well forward, providing easy access to the rear seats.

Interior lights, trunk lights, and lighting for the glove compartment and ashtray make it easy for the driver to find his way around the Porsche in the dark. A make-up mirror is fitted into the passenger's sun visor.



A pair of seats in the rear can accommodate two additional passengers.

**Space for luggage and other gear.**

Porsche 924 differs from many other members of the sports-car elite in its limitless versatility in everyday use and its remarkable load capacity. The 924 and 924 Turbo are deliberately designed as fast, efficient sports cars. Nevertheless, ample storage space is provided for luggage and other neces-



sities. The rear seatbacks can each be laid flat separately, creating additional luggage compartment space as needed. A cover, which unrolls automatically, protects the luggage compartment from prying eyes and direct sunlight.

The large hatch cover, held open by pneumatic springs, permits clean, convenient loading and unloading of even bulky cargo.

Storage areas are located to the right and left beneath the floor cover-

ing in the trunk. The 924 and 924 Turbo are equipped with space-saving collapsible spares. An electric compressor is provided to inflate it. This unit can also be used to inflate motorcycle and bicycle tires.

Specifications, standard equipment and options are subject to change without notice.

# Engine:

## A powerful two-liter powerplant.

The two-liter Porsche 924 engine delivers 110 hp. In the 924 Turbo, a somewhat modified four-cylinder engine, equipped with an exhaust turbocharger, develops 154 hp.

The source of this power is designed as a compact, water-cooled in-line engine, installed longitudinally in front. The cast-iron engine block is enclosed at the bottom by an aluminum oil pan. The cylinder head is a light alloy.

The forged crankshaft runs in five main bearings. Utmost care has been used in achieving dynamic and static balance in the crankshaft components. This ensures quiet, low-vibration operation even at full speed. A spur belt drives the overhead camshaft. Cup valve lifters open and close the row of overhead valves.

## Energy on demand.

All Porsche engines operate with fuel injection. For easy, all-weather starting, Porsche 924 uses a proven oxygen-sensing CIS fuel injection system, 3-way catalytic converter, and maintenance-free breakerless transistorized ignition. The CIS fuel injection system provides highly efficient fuel burning for a combination of economy\* and low exhaust emissions.

This highly reliable CIS fuel injection system, also known as Bosch K-Jetronic, requires little maintenance. It permits instantaneous changes in engine speed, easy starting, and quick warm-up.

An ignition spark at the "right" moment, a prerequisite for effective combustion, is supplied by a breakerless transistorized ignition system in the 924. The impulse that triggers the spark is supplied by induction. A rotor in the distributor induces the required control pulses in a stationary coil. These pulses are processed in a switching device so that they can be fed through a power stage to activate the high-voltage ignition coil.

During its entire life, the ignition system works with unvarying precision.

## Timing the Turbo: digital ignition.

Optimum ignition timing, delivery of the spark at precisely the right instant, is decisively influenced by the operating phase of the engine. To achieve the 924 Turbo's low fuel con-

sumption, favorable exhaust emissions, and high power output, Porsche incorporated a state-of-the-art ignition system using advanced digital timing technology.

The 924 Turbo uses its digital ignition system to obtain a unique combination of economy\* and power:

- low fuel consumption during starting and warm-up result from proper ignition timing;
- gasoline saving due to optimum enrichment of the fuel/air mixture when operating under full load;
- steady idling, even when components drawing heavily on the electrical system are turned on;
- low emissions due to increased engine efficiency;
- quick delivery of power at low RPM's;
- automatic, electronic limiter, designed to prevent over-revving;
- less stress on engine components as a result of unvarying precision in ignition timing.

The engine's reliable oil system provides circulating lubrication under pressure, with a full-flow oil filter in the main line. Both the normally aspirated and the Turbo engines require unleaded gasoline.

When the engine is subjected to a high thermal load, the cooling system is cooled by a temperature-controlled electric fan.

## Turbo engineering: leadership based on powerful thrust.

The turbo engine's extraordinary 40% gain in power, compared with the normally aspirated 924, is achieved without increasing displacement or engine rpm. Instead a turbocharger, driven by a stream of exhaust gases, increases the 110 hp output of the normally aspirated engine to 154 hp. This technology places no limits on the engine's suitability for daily use.

Elasticity or smoothness of operation are unaffected. In fact, 924 Turbo makes its added power available at moderate engine speeds and reaches peak performance at just 5,750 rpm, same as the normally aspirated 924.

Porsche has devoted particular attention to obtaining a fluid transition as the turbocharger cuts in. For this purpose, an 8.0:1 compression ratio was selected, along with a compact turbo unit. With its small rotating mass, the turbocharger rapidly arrives at high speeds—up to 100,000 rpm—so that its boost is felt quickly and smoothly.

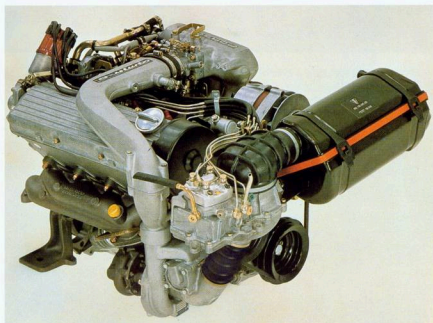
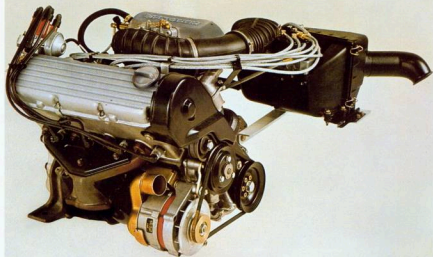

## Input from Porsche provides the dynamics of tomorrow.

Porsche made the Turbo engine practical for everyday use with the development of the turbocharger pressure control on the intake and exhaust side. Introduced to series production in the 911 Turbo, this device has been modified and incorporated into the 924 Turbo.

In use it operates as follows: when a powerful stream of exhaust gases drives the turbocharger pressure above a prescribed limit (0.45 bar), a waste gate valve opens. A portion of the exhaust gas then bypasses the turbine and flows directly into the exhaust pipe. Turbocharger pressure remains at the desired level at all times.

A second safety check, the so-called by-pass valve, is incorporated

in the compressor housing of the 924 Turbo. It prevents pressure from building up between the compressor and the throttle valve when the driver takes his foot off the accelerator. The valve opens to protect these components from damage, permitting fresh air to be drawn in and circulate freely around the charger. The load on the turbine is reduced, and the momentum of the entire system is maintained. When pressure is again applied to the accelerator, full pressure is rapidly restored.

## Cooling power.

The turbo engine, with its theoretical total compression ratio of up to 11:1, generates higher pressures and temperatures than the normally aspirated engine. To satisfy the Turbo's

Schematic layout 924 Turbo

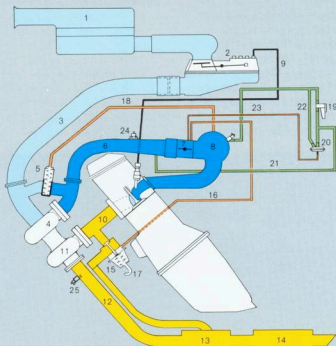

- Induction air
- Pressurized air
- Control pressure line
- Exhaust gases
- Additional air

- |  |   |
|--|---|
| <ul style="list-style-type: none"> <li>1 Air filter</li> <li>2 Mixture controller</li> <li>3 Intake line</li> <li>4 Turbocharger (compressor)</li> <li>5 Blow-off valve</li> <li>6 Pressure line</li> <li>7 Throttle valve</li> <li>8 Air distributor</li> <li>9 Fuel injection line</li> <li>10 Exhaust manifold</li> <li>11 Turbocharger (turbine)</li> <li>12 Exhaust gas line</li> <li>13 Muffler</li> </ul> | <ul style="list-style-type: none"> <li>14 Muffler</li> <li>15 Boost pressure control valve</li> <li>16 Control pressure line (boost pressure control valve)</li> <li>17 Vent line</li> <li>18 Control pressure line (blow-off valve)</li> <li>19 Auxiliary air valve</li> <li>20 Vacuum limiter</li> <li>21 Line to auxiliary air valve and vacuum limiter</li> <li>22 Connecting line</li> <li>23 Control vacuum line</li> <li>24 Boost pressure control switch</li> </ul> |
|--|---|

higher cooling requirements, a separate full-flow oil cooler has been installed in the right front wheel arch. This unit draws off heat produced due to the higher levels of energy throughput. Additional air intakes ventilate the engine space, and the NACA vent on the hood increases cooling without creating a major aerodynamic disadvantage.

The most important difference in the Turbo engine is the cylinder head. Optimum design of the combustion chamber, elongated exhaust valves, and spark plugs (with platinum or silver electrodes) set into the intake side,

ensure a combustion process attuned to the Turbo's special requirements.

\*1982 EPA estimates. 924—20 estimated mpg, 35 estimated highway mpg (manual); 924 Turbo—20 estimated mpg, 33 estimated highway mpg. Use "estimated mpg" for comparison. Your mileage may vary with weather, speed, and trip length. Actual highway mileage will probably be less.

924 Turbo digital ignition system

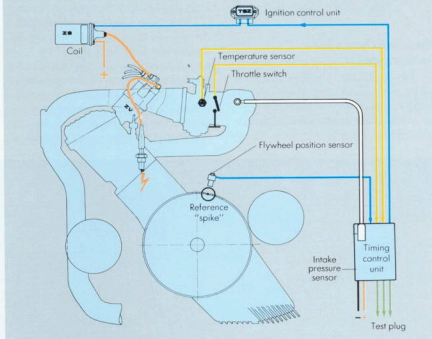

Full-power Curve

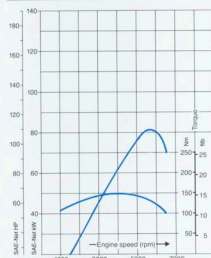

Full-power Curve

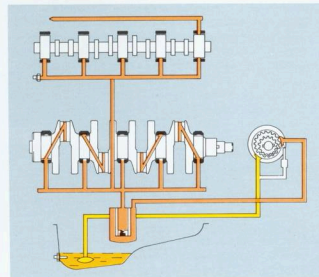



## Chassis:

### New methods for new models.

No doubt about it: Porsches have long distinguished themselves, not only through superb engine performance, but also by their ability to execute tight turns at track speeds—in other words

by providing an abundance of control when driving and turning. The 924 and 924 Turbo acquired this ability long ago, during their design phase.

For those interested in technical details, a glance beneath the surface reveals a transaxle design which makes a decisive contribution to good road-holding and safe driving. The two axles are loaded almost identically; the front axle supports the engine; the rear one supports the transmission, differential, gas tank,

and spare tire. This balanced load distribution approaches 50:50, permitting optimum control of steering and handling thrust.

Low center of gravity and high polar moment of inertia ensure directional control. Porsche 924 holds the road, hardly requiring counter steering on curves. The car is virtually insensitive to crosswinds and easily converts its power into forward thrust, even on wet road surfaces.

The 924's precise rack and pinion

steering system <http://coochas.com> cleanly to the driver, providing virtually ideal contact with the road surface under a wide range of conditions.



## Porsche builds sports cars engineered for safety.

The chassis of the 924 superbly satisfies two opposing design requirements: it makes a decisive contribution to the handling characteristics of a dynamic sports car with a high degree of active safety. At the same time, it is the basis for the smooth ride that makes fast travel comfortable.

Each front wheel is individually guided by lower and transverse

control arms. Each wheel has its own spring suspension, with a coil spring positioned coaxially to the MacPherson strut.

The rear axle design includes semi-trailing arms to guide the wheels and trailing arms for the suspension. A sturdy transverse tube separates the rear axle from the body and holds the transverse-mounted torsion bars.

Both the 924 and 924 Turbo are equipped with 0.85-inch (21.5mm) diameter front stabilizers and new,

stronger torsion bars. An optional 0.55-inch (14mm) diameter rear torsion bar, gives the Turbo even greater road-holding ability in fast turns and during emergency maneuvers.

Since the Turbo engine is somewhat heavier than the powerplant of the 924, the suspension had to be adjusted accordingly. Recommended air pressure of the rear tires was increased, and the car has been fitted with tighter shock absorbers. Increased sportiness is not achieved at

the expense of a comfortable ride. The rolling, roadholding and suspension characteristics of the 924 Turbo are on a par with those of Porsche 924.

The Porsche 924/924 Turbo front suspension

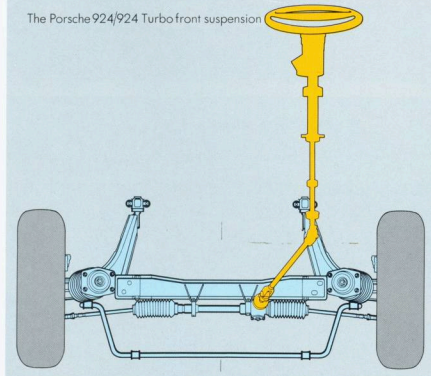

The Porsche 924 Turbo rear suspension

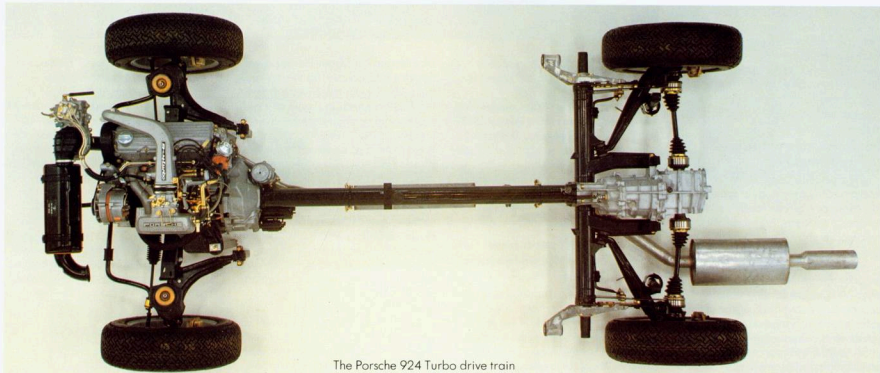
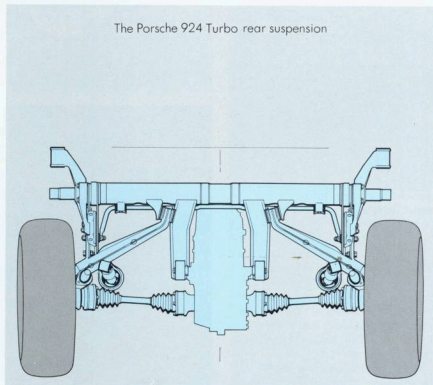

The Porsche 924 Turbo drive train

# Power Transmission:

## Straight-line transfer.

A sturdy torque tube connects the engine and transmission of the trans-axle Porsche to form a rigid drive train. The maintenance-free transmission shaft turns in the tube at the same speed as the engine.

In manual-transmission vehicles, a single-disc clutch transmits engine power through the drive shaft to the transmission. From here, it passes to the driven rear wheels through differential gears and double CV-joints.

The Turbo engine has nearly 40% more torque than its normally aspirated sister, 154.8 vs 111.3 ft. lbs. This extra "twisting power" requires a few modifications. The larger clutch of the 924 Turbo is designed to match its substantially higher torque output. It is easy to operate, requiring only light pedal pressure. In the 924 Turbo, the clutch is hydraulically operated. In the 924, it is mechanically activated. The diameter of the Turbo's central shaft has been beefed up from 0.8 to 1.0 inches. Thus, it requires only three intermediate bearings in the transaxle tube instead of four. The axle shafts have also been enlarged and the gear ratios slightly altered.

For the most exacting sporting requirements, Porsche offers a limited slip differential with a 40% slip limit as an option. The experienced driver can use its improved power transmission to increase thrust when taking turns at track speeds. Limited slip also aids fast get-away when there are significant differences between the friction coefficient of the left and right drive wheels, for example on slippery road surfaces, gravel, snow and ice.

## Performance attuned to the times.

High power obtained through energy-consuming engine speeds is just as inappropriate today as low torque. A modern, high-performance automobile should be powerful, yet civilized.

In this regard, the 924 4-cylinder engine reflects the Porsche philosophy. Not just in its ability to function economically, but also as a versatile vehicle for satisfying the transportation needs of its owner.

The 924 Turbo boasts a top speed of 134 mph and accelerates from 0 to 60 mph in 9.0 seconds. The normally

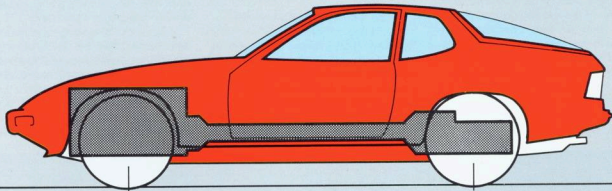

aspirated 924 takes 10.8 seconds to reach this speed. Its top speed is 120 mph.

Both models are equipped with five-speed transmissions as standard equipment. Performance driving in either vehicle is as easy on the nerves as it is on the gas tank.

In 1980, the engine output of the 924 Turbo was increased over that of the previous model, yet its fuel consumption was reduced by 10%.

## Power flow from a new perspective: the automatic transmission.

If its owner so desires, Porsche 924 can be equipped with a fully automatic transmission. In this version, the clutch is replaced by an elastic driving disc, at the engine, and the drive shaft still turns at engine speeds. At the rear end, it drives the impeller

of a torque converter. Here, power transfer is taken over by the hydraulic fluid. In this way, the driveshaft mates in a "soft connection," with no rigid mechanical junction between the motor and the drive wheels. Power flows to the axle drive with a minimum of noise, vibration, and wear on the components.

Automatic choice of the most favorable gear ratio, tuned precisely to the output of the engine, gives the driver optimum performance in every situation. Sport-style driving remains uncompromised. And quick response to unexpected circumstances is made possible by carefully pre-selected shift-up and shift-down points. Without using the shift lever, the driver can still "kick down" at a relatively late stage to obtain a lower transmission level permitting faster acceleration.

The top speed of the automatic

924 is 116 mph. It takes 12.7 seconds to accelerate from 0 to 60 mph.

Assuming they make full use of their car's performance potential, 924 drivers who order their Porsche with an automatic shift will use slightly more gas than manual-shift drivers. But they will likewise experience lower fuel consumption\* when driving in city traffic.

The convenience of automatic shifting in a Porsche places neither a limitation on its sportiness nor a loss of mobility. It is rather a deliberate choice to reduce the driver's duties and obtain concentrated, relaxed driving pleasure.

### Transmission Diagram

Manual gearbox

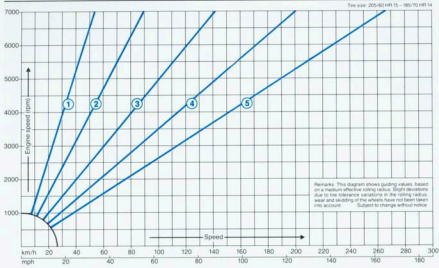

Remarks: This diagram shows guiding values, based on a medium vehicle using urban, light, light-recreational and long-haul driving conditions. The driving behavior and stability of the vehicle have not been taken into account. — Shift to a higher without notice

### Acceleration Curve

Manual gearbox

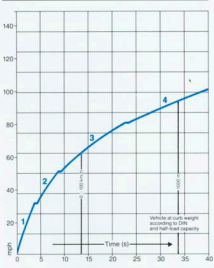

Vehicle at curb weight according to EN and full fuel capacity



### Transmission Diagram

5-speed-transmission

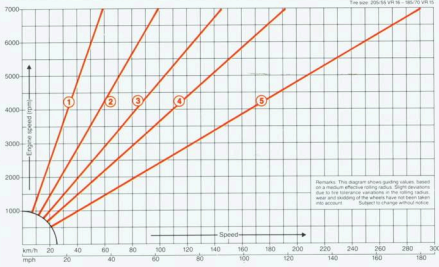

Remarks: This diagram shows guiding values, based on a medium vehicle using urban, light, light-recreational and long-haul driving conditions. The driving behavior and stability of the vehicle have not been taken into account. — Shift to a higher without notice

### Acceleration Curve

5-speed-transmission

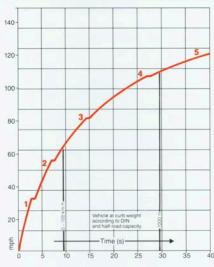

Vehicle at curb weight according to EN and full fuel capacity

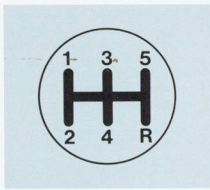

### Transmission Diagram

Automatic

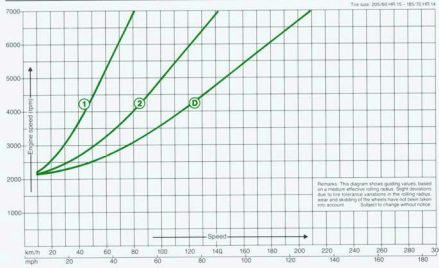

Remarks: This diagram shows guiding values, based on a medium vehicle using urban, light, light-recreational and long-haul driving conditions. The driving behavior and stability of the vehicle have not been taken into account. — Shift to a higher without notice

### Acceleration Curve

Automatic

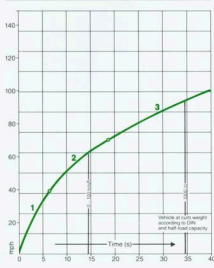

Vehicle at curb weight according to EN and full fuel capacity

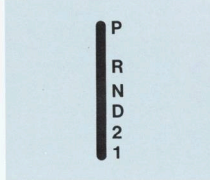

\*1982 EPA estimates. 924- (21) estimated mpg, (28) estimated highway mpg (manual); 924 Turbo - (20) estimated mpg, 33 estimated highway mpg. Use "estimated mpg" for comparison. Your mileage may vary with weather, speed, and trip length. Actual highway mileage will probably be less.

# Brakes, Steering:

## A close relationship within the Porsche family.

With its exceptional power-to-weight ratio, just 18.05 lbs. per hp, Porsche 924 Turbo is one of a select breed of sports cars on the road today. At the same time, it is also designed for safety. This is based in part on an outstanding brake system. Matched to the sporting chassis, the sure, effective brakes let the driver experience effortless power while retaining full confidence in his ability to stop within a reasonable distance. This confidence is fully justified since the brakes in Porsche 924 Turbo bear a close resemblance to those of the 911SC and 928.

Numerous components tested in the 911SC and 928 have been adopted for the 924 Turbo. In addition to rugged wheel bearings, these include a five-bolt wheel-fastening system and the hydraulic dual-diagonal brake system. Four floating caliper disc brakes help tame Porsche 924 Turbo's high power, providing a very comforting 60 to 0 stopping distance, at light load and on a dry road, of just 148 feet.

All four brake discs are internally ventilated to prevent fading during hard braking. As in the 928 and 911, the parking brake operates through separate drums on the two rear wheels.

To accommodate its larger brakes, 924 Turbo is equipped with 15-inch wheel rims. They carry high-speed radials, size 185/70VR15.

The dual-circuit diagonal brake system of the 924, with disc brakes in front and drums at the rear, utilizes the same 9-inch power booster as the Turbo. A light pressure on the pedal brings the car sensitively to a halt. From 60 mph at light load and on a dry road, the 924 can come to a dead stop in 148 feet.

**Reliable radials.**  
Tubeless radial tires, size 185/70 HR14 are mounted as standard equipment on the 6J x 14 light-alloy rims of the Porsche 924.

For both 924 models, special sizes can be obtained at additional cost: cast 6J x 15 spoke wheels with Series 60 radials for the 924; 6J x 16 forged wheels with 20S/55VR16 low profile radials for the 924 Turbo.

**Holding its course.**  
Sheer power, plus the ease with which it is used, combine to make Porsche 924 such an impressive sports car. The transaxle Porsche makes precision driving easy. Its high output, reassuring road-holding capability, and precise steering mean that the vehicle imposes few demands on the driver.

The 924 responds with accuracy to every movement of the steering wheel. Even when taken through a curving course at high speeds by an experienced driver, the car requires little or no correction. At speeds barely reached by conventional automobiles, all that is normally needed to keep the 924 on course is a slight movement of the wheel.

The ability to hold the road in tight curves is aided by the absence of troublesome body roll. Complementing this characteristic is negative steering roll radius, an advanced suspension geometry that helps the driver maintain directional control, even when front-tire roll resistance varies. This is particularly important when braking on uneven surfaces or stopping with a blow out.

## With Porsche, driving has always been and will always be fun.

Driving a sports car is probably the most individual means of locomotion, and undoubtedly the one that gives the greatest pleasure to the enthusiastic driver. In Porsche 924, the driver can find a rational basis for this enjoyment.

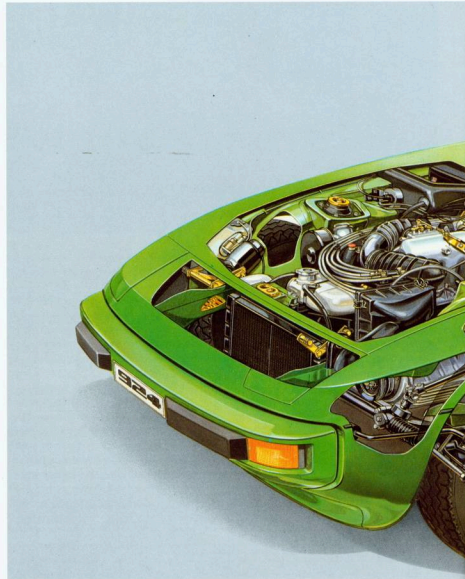
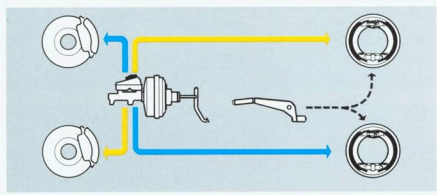
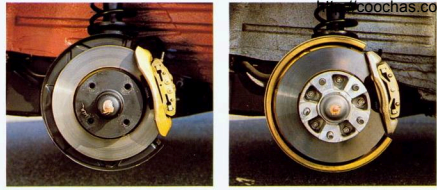

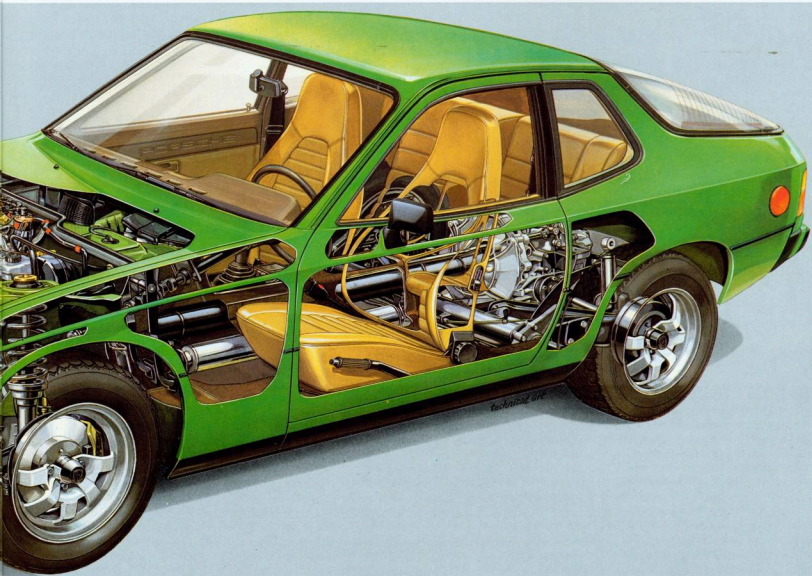

# Research in the Countryside:

ation. The coveted reputation that is the outgrowth of this performance is due to one overriding Porsche concept: a unique, all-embracing commitment to excellence.

Add to this perception a knowledge of the amount of research, engineering, and race-honed experience that go into every Porsche, and the scope of the Weissach investment becomes easily understandable.

## After nearly two decades, Porsche has a wealth of new ideas.

The pioneer auto-makers conceived and executed their design concepts according to their own personal ideas, striking a delicate balance between often conflicting requirements.

These requirements have undergone a fundamental change. The automobile has become a tool taken for granted. A tool that must meet measurable requirements in terms of fuel economy, performance, driving safety, environmental restrictions, and

### The Weissach team.

Half an hour's drive from Stuttgart, nestled in rolling green fields, is Porsche's most important capital investment, its "think tank." The Research and Development Center at Weissach covers some 450,000 square meters. It is even larger than Porsche's Zuffenhausen production plant. This relationship is unique in international automobile manufacturing. But when applied to Porsche, it is far from paradoxical.

Porsche builds unusually successful sports cars. With their high investment in precision and technical excellence, these sports cars win victories on the track and praise from those who depend upon them for daily transpor-



preservation of value. Today, no one person can strike the required balance between these conflicting claims.

At Weissach, more than 1,000 scientists, mechanics, engineers, and technicians are working together to formulate viable solutions for the future. In fact, every fifth employee at Porsche is contributing to this work.

The Weissach environment is itself evidence of the thoroughness with which Porsche lays the groundwork for its future successes. At Weissach, Porsche ideas are born in an environment in which creativity and innovation are highly prized. If valid, these ideas take shape and progress from initial sketches to products ready for production. At Weissach, all Porsche factory race and rallye cars are built, tested, and tuned.



### Porsche 995: Window to the future.

At the request of the Federal Ministry of Research and Technology, the Weissach Development Center has developed an innovative concept for the sports car of the future. Concentrating on safety, low energy consumption, and noise reduction, Porsche has designed an automobile that in every respect represents a significant advance over all sports cars in production today.

Research started with two basic premises: offering as much space as today's sports cars, and a 0-60 mph acceleration time of 10 seconds.

The "Porsche 995" study reveals some astounding results. By cutting the drag coefficient to 0.30 and matching a suitable engine and transmission to this aerodynamic body, fuel consumption has been raised to 30 mpg.\*

\*Obtained at a steady speed—not comparable to the EPA test-method.



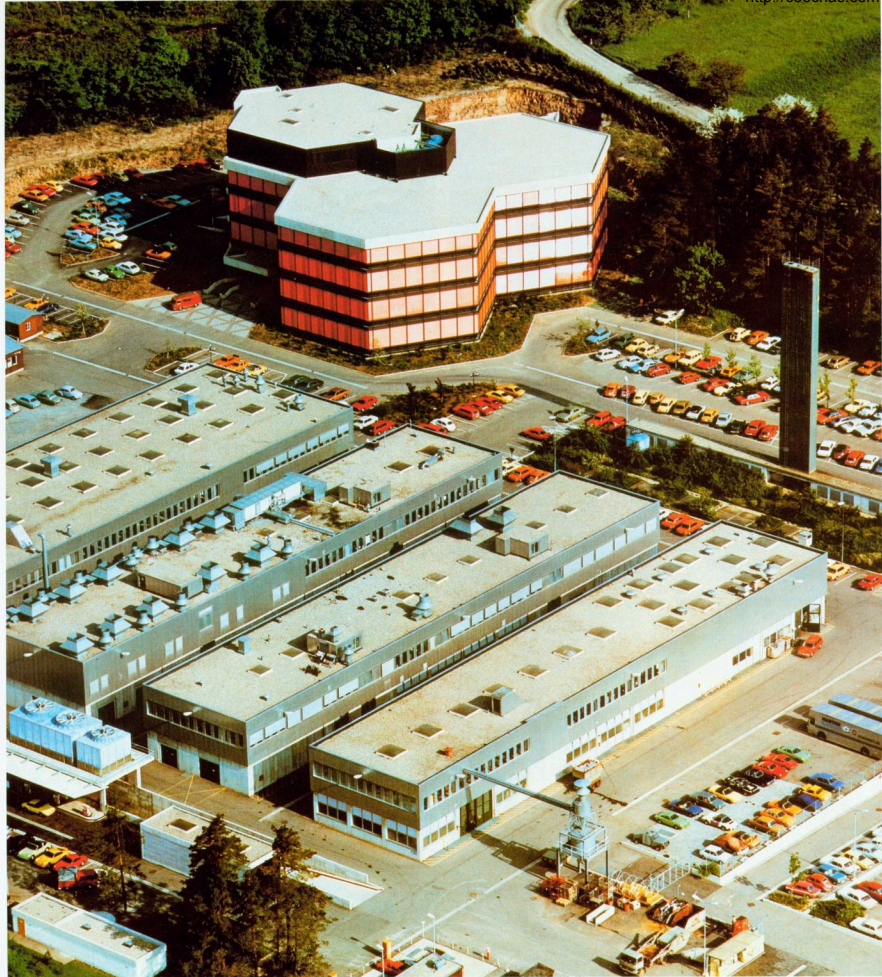



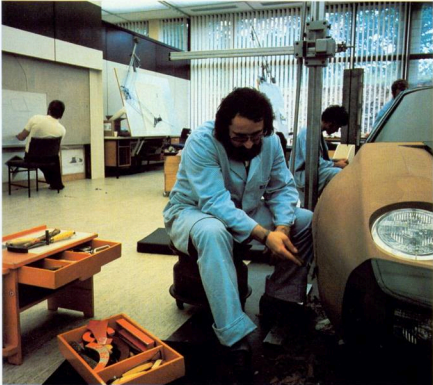

On the basis of detailed preliminary studies, preference had been given to the gasoline engine over the Diesel and other alternative drives. To ensure that the 995 can always operate within its highest efficiency range, a novel load-switching transmission was designed with an electronically controlled shift.

In spite of the car's reduced weight, both the passive safety of the all-aluminum body and the active safety of the chassis have been in-

creased. Total enclosure of the engine, together with other damping methods, have decreased noise emission to the 72 dB limit imposed by road noise.

Though at present the 995 is only in the study phase, realization of the ideas embodied in it can be expected just as soon as the technology required for series production is available.



**Others come to Porsche for the thinking that has made Porsche exceptional.**

Only about 50% of Weissach's capacity is used by Porsche for its own research and development. The other half is employed in research contracts, studies, and development projects for government agencies, institutes, and manufacturers of accessories and tires.

Creativity under contract is a long standing tradition at Porsche. The company's founder, Prof. Ferdinand Porsche, was himself engaged in it. And such famous names as Panhard & Levassor in Paris, Austro-Daimler and Daimler-Motoren-Gesellschaft in Stuttgart were among his customers. In Stuttgart, at Dr. Ing. h.c. F. Porsche GmbH, founded in 1931, he designed the Beetle, the prototype of all subsequent Volkswagens.

**New frontiers.**

The innovative styling concepts that makes Porsche so eye-catching also make it aerodynamic and fuel efficient. The models for these concepts originate at Weissach in the styling studio.

Passenger safety is not neglected in the process. This is amply demonstrated by the well-protected passenger compartment included in all new Porsche designs, and the integration of such experimental passive restraint systems as airbags and automatic seat belts in the 995 project.

**Engineering the engine.**

Engineering development, always a Porsche speciality, continues to focus on the refinement of the internal combustion engine. The reason is quite simple, the gasoline engine offers significantly higher design flexibility than all others.

Single-cylinder test engines are used for systematic investigation of various combustion chamber configurations. The goal: a high-compression engine that uses more air and less fuel to improve efficiency by up to 40%.

Since top driving performance will continue to be a prime consid-



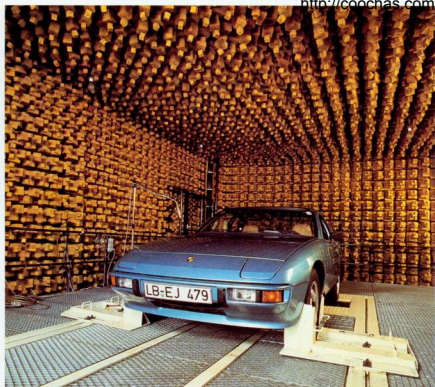

eration in sports cars of the future, Porsche continues its efforts to exploit the remaining margin for development. For this purpose the computer is an outstanding tool. Its ability to record and assimilate masses of data with precision, accuracy, and speed greatly shortens the testing period. Results obtained can be channeled directly into the ensuing development phase.

Porsche's Weissach Development Center has a computer that simul-

taneously monitors and controls eight engine test stands. Endurance tests are run and recorded, characteristic curves are plotted, exhausts are measured and analyzed, and braking is carefully measured. Data from a test run is recorded, processed, and stored in just 0.04 seconds. Thus the Weissach computer still has plenty of time for complicated calculations, printing out records, and presenting visual conceptions of the vibration characteristics of a car's body design.

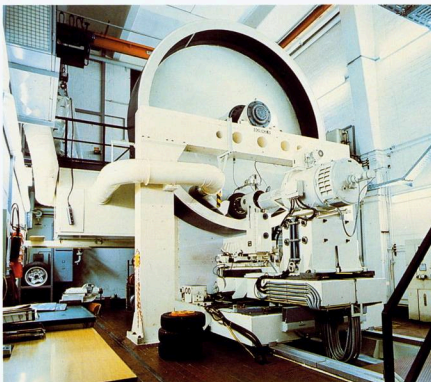
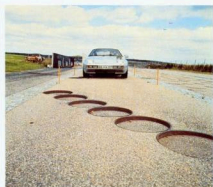
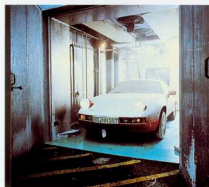

**Quiet efficiency: the sound measurement laboratory.**

Porsche invests substantial sums on extensive oscillatory and acoustical testing to analyze such questions as whether and at what point the rapidly spinning drive shaft in the torque tube of a 924 or 928 will begin to resonate. Or analyzing how high-frequency vibrations and noise emission from the heat exchanger of the 911 engine can be further reduced.

The vibration suppressor in the transaxle unit of Porsche 924 is a good example of computer-assisted optimization in prototype development. The unit consists of a cylindrical casting, which is supported in the carrier tube by elastic butyl rings. This Porsche development suppresses resonance peaks that would otherwise be heard as a droning noise.

**Testing grounds.**

Porsche engineers are living proof that building sports cars stimulates imaginative technical solutions. Their efforts make Weissach's output greater than that of many other development centers with far more space and personnel.

New models undergo their first trials on computerized test stands. Here they must prove their ability before Porsche elects to translate efficient technology into motion on the outdoor proving grounds: negotiating steep grades, fighting "torture" and vibration courses, circumnavigating a pair of circular race tracks, and coping with a highly demanding slip pad.

# Safety:

## A complete system.

Porsche has an excellent record of building cars that incorporate state-of-the-art measures for achieving active and passive safety. As the manufacturer of the 935, among the "most potent" racing cars ever built. As a frequent world champion. At Le Mans. And at the IMSA races held in the USA.

A Porsche imparts to its driver an ever-present air of safety. The technology inherent in this car has proved its worth from the outset, far earlier than ordinarily with conventional cars. The extensive safety trials conducted by Porsche in the course of its body testing provide convincing proof.

## Front-crash test.

Crashing into a 90-ton barrier at 30 mph, Porsche's deformable front absorbs so much energy that the layout and operation of the restraint system can fully come into play. This helps the seatbelts reduce strain on passengers due to deceleration forces.

The hood is designed to buckle in a controlled manner. The catch, in combination with the hinge, helps hold the hood and prevent it from penetrating the windshield.

The transaxle is designed to prevent the motor from penetrating the passenger compartment. The rigid connection between the engine in front and the transmission in back conducts forces backward. In a rear-end collision, forces are projected forward. In both cases, energy forces are directed away from the passenger compartment.

The laminated safety-glass windshield is installed with a strong adhesive designed to hold it in place during the barrier crash test, maintaining the integrity of the closed compartment.



### Testing the steering system.

This test measures rearward displacement of the steering wheel when the car is driven at 30 mph into a solid barrier. In the Porsche, horizontal displacement of the steering wheel is far below the permissible 5-inch maximum.

### Steering-wheel impact test.

In this test a dummy is used to determine impact force with the steering wheel in every possible position. The steering console, designed to give way in the line of force, provides an additional deformation path to absorb energy in the event of an accident.

The large impact plate on the steering wheel is appropriately upholstered. Directly behind the impact plate is another deformation element. This aligns the steering wheel in the direction of impact during the initial collision phase, helping to distribute the force over the greatest possible area. Through this built-in deformation process, kinetic energy is converted into deformation work, effectively reducing the amount of stress.

### Testing side-door strength.

A 4000 lb. barrier is driven against a stationary car at 21 mph. Safety locks are designed to keep doors shut during this collision.

Porsche's safety engineering helps ensure that the doors can be opened afterwards from both inside and out.

Static indentation tests are performed to check lateral protection.

### Trials of roof strength.

A rectangular plate is forced at an angle into the roof of the car close to the windshield post. The roof construction of Porsche 924 forms a rigid, integrated bearing structure that is designed to act as a rugged rollover cage.

### Rollover test.

The test car is catapulted sideways at 30 mph by a test sled. Porsche 924 rolls over several times. Both doors are designed to remain closed. The body, strengthened at three levels, helps prevent the roof from caving in.

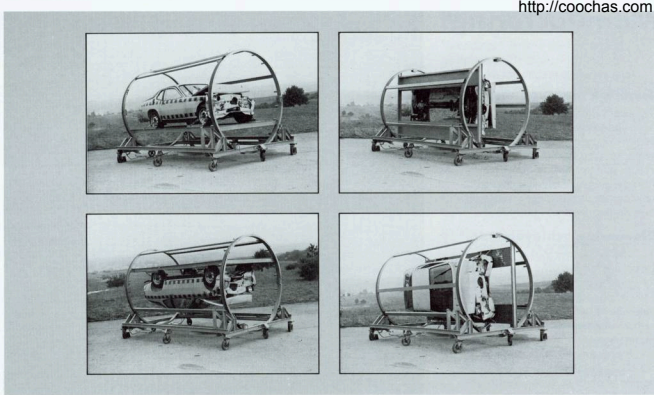

### Designed for safety.

Energy-absorbing materials are used at critical points to upholster the interior of Porsche 924. The flexible dashboard, with its shatterproof instrument cluster, extends into the leg well. Instrument housings, door handles, and the glove compartment lock are deformable or recessed. The interior rearview mirror is held by a flexible mount instead of a rigid fastener.

All materials used in the interior of the 924 are highly flame-retardant.

A number of external features of Porsche 924 are designed to help protect pedestrians and other cars, as well as the Porsche itself.

One such detail is the extended, gently inclined hood. Another is the exterior rearview mirror designed to fold up in both directions. The rain channels are integrated with the body design. The front wiper arms are covered by the hood; the rear wiper arm by a cap.

The headlights are retractable, eliminating protruding edges. Even when up, the headlights present only smoothly rounded contours.

Energy-absorbing bumpers with a wide radius, installed front and rear, are integrated into the shape of the body. This helps provide safety for all those involved in a collision. The bumpers are attached to energy-absorbing elements that help protect the car body from damage.



# Manufacturing:

## Swabian thoroughness.

Every Porsche is a unique creation. The carefully planned production sequence, strategically-positioned work stations, and critical system of checks and tests ensure that every Porsche comes off the line and to its new owner as a proud example of outstanding Swabian precision.

## Pioneering achievements.

The 4-cylinder 924 and 924 Turbo are not merely a new standard for Porsche performance capability. They are expanding the horizons of automobile production as a whole with an impressive array of advanced technologies.

Porsche makes extensive use of hot-dip galvanized sheet steel for the bodies of all of its series, leading the way in the automotive industry. The manufacturing problems this process presented were monumental. The deep-drawing characteristics of the sheet metal and drawing tools had to be examined. Since zinc is softer than steel, suitable deep-drawing lubricants, preservatives, and transport pallets had to be developed to protect zinc surfaces of deep-drawn body parts from damage.

Yet another example is the difficulty inherent in obtaining color uniformity and adhesion on metal and plastics. New enamel systems were developed to resist cracking, splintering, and peeling, even under extreme deformation of elastic polyurethane body parts.





### Quality takes shape

A long time must pass before the "wedding." Before the completely equipped body and chassis can be united with the engine and transmission, the new Porsche will have undergone numerous metamorphoses.

The entire process begins with the shell. First the deep-drawn body parts are welded together. Precise welding is essential for a tight, noiseless body. The surface is checked and re-checked for faults. If even the smallest defect is discovered—the body shell will be sent back to the preceding work station.

Porsche 924 is primed using a special electro-immersion process. Before the body is painted, it must undergo another inspection. Then the joints are sealed.

### Crystallization points.

Painting a car of the caliber of Porsche 924 places high demands on workmanship and technical equipment.

Every detail is marked on a routing card that accompanies the car from the very start: the color of the exterior finish, whether the seats are to be fine-cloth or supple leather, and what their color will be.

Simultaneous with the construction of the body, the drive train and chassis are being assembled in the machine shop. One of the crystallization points in the building of a Porsche is the engine assembly. Here precision and conscientiousness are valued high above mere speed.

After final assembly, the car is ready to be driven. But first it must be closely examined from stem to stern. Then comes an inspection on the dynamometer and a complete performance check-out. At last, the new Porsche is ready for its owner.



# Value Retention:

## Use without regrets.

### Point 1—Porsches are built to last.

Porsche perfection is based on two equally important components: design quality and manufacturing quality. To ensure that the latter keeps pace with the former, every detail of a Porsche is subjected to unflinching visual inspection, operating checks, and test-stand evaluation.

This effort ensures the mechanical precision that keeps Porsche technology functioning through years of use. To prevent creeping corrosion from reducing its high value, the body of a Porsche is built as a long-life cell.

Porsche 924 begins life as sheet steel that has been hot-galvanized on

both sides. While still in strip form it is passed through a liquid zinc bath at 932°F. The high-temperature causes the zinc to diffuse into the steel, forming a close-linked iron-zinc alloy. When the strip is withdrawn from the bath, pure zinc is deposited atop this layer in a protective film.

Parts of the floor assembly subject to special danger from water spray receive a coating of .9 ounces of zinc per square foot of sheet steel. Together with a high-quality painting process that has proven its worth over many years, this gives the Porsche two-fold corrosion protection: the paint protects the zinc and the zinc protects the steel.

The floor of the car, wheel housings, front fenders, and side rocker panels are coated with polymer vinyl. The protective undercoating and the joint seals are burnt in. In addition, protective wax is sprayed into all hollow spaces.

A body treated in this manner will withstand corrosive elements for many

years. If the zinc coating suffers a minor mechanical injury, so that the steel is exposed, moisture will have a "curative" effect on the damaged area. Zinc ions migrate to the iron and neutralize the exposed steel surface. The zinc allows itself to be oxidized to protect the steel. Structural body parts are extremely well preserved by this effect. The sturdy body structure of the Porsche remains intact.

During spot welding the zinc coating is vaporized or melted away around the electrodes. The zinc enclosed between the plates also melts, forming a protective circle around the weld nugget.

A body so protected will withstand a lot of punishment. At the Porsche plant, a test body was sprayed for 240 hours with a 5% salt solution at an ambient temperature of 95°F. This was repeated several times. Afterwards, the car was as immaculate as ever.

### Point 2—a Porsche always retains its value.

Other manufacturers provide a limited warranty against rust perforation for a period of years. Porsche remains the exception, however, with a limited warranty that requires no subsequent treatment. Even after years of intensive use, the protective undercoating needs no retouching. The hollow spaces in the body require no renewal for continued protection.

Porsche limits itself to one requirement: damage due to mechanical causes should be remedied.

Starting with the '81 models, the Porsche limited warranty against rust perforation was extended from 6 to 7 years. Not only for the floor assembly, but for the entire body shell. No subsequent treatment is required. The limited warranty does not become invalid upon change of ownership. And, naturally, the 7-year term applies to all Porsche models. Ask your dealer for complete details.

#### Rust perforation on a coated steel plate

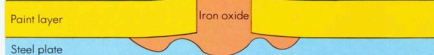

#### "Slowed-down" rust infiltration on a galvanized steel plate

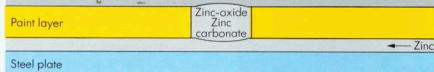

#### Outer body finish

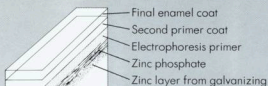

#### Underbody finish

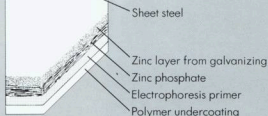

**Point 3—A Porsche has modest requirements.**

High-performance sports cars can be economical if they are built with new concepts and technologies and not constantly driven at their top speeds. Using this concept, Porsche produces sports cars in which rational fuel consumption\* and pleasing performance are far from mutually exclusive.

The small front surfaces and low drag coefficients reduce energy-consuming air resistance. Engines, transmissions, chassis, and bodies are fabricated from strong, light alloys to lower vehicle weight and reduce energy loss during acceleration and braking. High-efficiency Porsche drive trains ensure a high output from fuel. Use of fuel-injected engines on all Porsche models cuts down on consumption through accurate fuel metering. And finally, reliable breakerless high-voltage ignition systems, which require no maintenance, optimize

Porsche engine performance throughout the life of the car.

Porsche engineers have tamed turbocharging to make it suitable for use in passenger cars. Porsche is also testing systems that shut off cylinders during idling or low-load periods. These may well be used in the economical sports car of the future.

\*1982 EPA estimates: 924—(20) estimated mpg, 35 estimated highway mpg (manual); 924 Turbo—(20) estimated mpg, 33 estimated highway mpg. Use "estimated mpg" for comparison. Your mileage may vary with weather, speed, and trip length. Actual highway mileage will probably be less.

**Point 4—A Porsche is there when you need it.**

Porsche 924 and 924 Turbo are sports cars you can count on. They offer their owners superb vehicles to help them cope with the daily challenges of traffic, assaults of the weather and the passage of time.

The maintenance requirements for this performance are small. Inspection every 15,000 miles and an oil change every 7,500 miles. But the dependability of the Porsche 924 is not measured solely in the long periods between maintenance and the limited number of tasks required. A substantial contribution is also made by the maintenance-minimizing design of the drive train, chassis and body.

The CIS fuel injection system operates with automatic precision. The spur belt which controls the cam and valves is positioned outside the engine for easy access. The cylinder head, along with its camshaft and valves, are easily accessible with the engine in

place. The front axle requires no lubrication. Wheel alignment can be made without replacement of parts. The rear axle tube is bolted on, as are the individual replaceable front fenders.

Minor failures in the on-board electrical network can be quickly located. The relays and fuses have been brought together in a central electrical panel at the left, beneath the dashboard.

As you can see, Porsche has done much to ensure that Porsche 924 will be there when you need it.

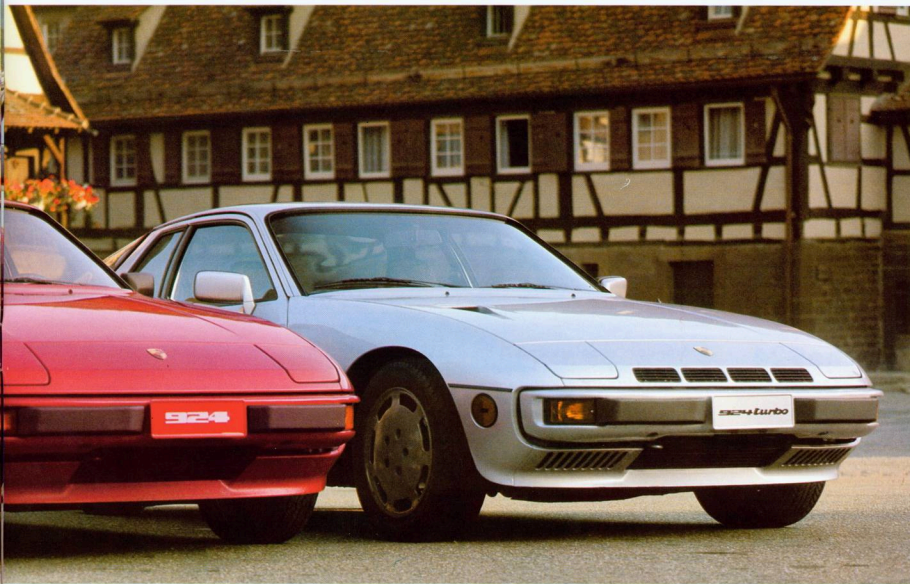



# Technical Data:

1982	924	924 Turbo
<b>Engine</b>		
Number of cylinders	4	4
Bore	3.41 in. (86.5 mm)	3.41 in. (86.5 mm)
Stroke	3.32 in. (84.4 mm)	3.32 in. (84.4 mm)
Displacement	121.0 cu. in. (1984 cc)	121.0 cu. in. (1984 cc)
Compression ratio	9.0:1	8.0:1
H.P. SAE net (kW)	110 (82)	154 (115)
at rpm.	5750	5750
Max. torque SAE net ft. lbs. (Nm)	111.3 (151)	154.8 (203.3)
at rpm	3500	3500
Max. rpm	6500	6500
Fuel requirement	Lead-free only	Lead-free only
Engine design	Watercooled, 4-cylinder in-line, front mounted	Watercooled, 4-cylinder in-line, front mounted
Crankcase, cylinders	Single grey cast block, aluminum oil pan	Single grey cast block, aluminum oil pan
Cylinder head	Light alloy	Light alloy
Valve placement	Overhead valves	Overhead valves
Valve train	Overhead camshaft	Overhead camshaft
Camshaft drive	Spur belt drive	Spur belt drive
Crankshaft	Forged, 5 main bearings	Forged, 5 main bearings
Engine lubrication	Pressure lubrication, full flow oil filter	Pressure lubrication, full flow oil filter
Fuel supply	2 electric fuel pumps	2 electric fuel pumps
Fuel/Air mixture	Continuous Injection System (CIS)	Continuous Injection System (CIS), with exhaust turbocharger
<b>Electrical system</b>		
Battery voltage	12	12
Battery capacity	63 Amp/h	63 Amp/h
Alternator output	Max. 1050 W	Max. 1050 W
Ignition system	Breakerless transistor ignition	Digital ignition system
<b>Drive train</b>		
Clutch	Single disc, dry	Single disc, dry
Transmission	Transaxle, rear	Transaxle, rear
Number of gears	5 forward, 1 reverse	5 forward, 1 reverse
Final drive	Beveled hypoid drive	Beveled hypoid drive
Drive axles	Double CV-joints	Double CV-joints
Shift lever location	In tunnel console	In tunnel console
Final drive ratio	9/37 = 4.111:1	9/35 = 3.888:1

## Porsche 924 924 Turbo:

### Standard appointments geared to Porsche's highest level of luxury.

- 2.0 liter four-cylinder water-cooled overhead cam front engine
- CIS fuel injection
- Transistorized breakerless ignition
- Five-speed fully synchronized rear transaxle
- Four-wheel independent suspension, MacPherson struts front, torsion bars rear
- Welded unitized body
- Integral front spoiler

- Power-assisted brakes, discs front, drums rear
- Dual diagonal brake circuits
- Negative steering roll radius
- Rack and pinion steering
- Protective exterior side moldings
- Alloy wheels
- Protective front and rear bumper moldings
- Lift-up hatchback
- Air conditioning
- Power windows
- Tinted glass all around
- Electric rear window defroster
- Corpeted rear luggage area with fold-down seatback

- Luggage compartment cover
- Roomy storage pockets in doors
- Full carpeting
- Inertia-reel seat belts, front, and lap belts, rear
- Center console
- Reclining bucket seats
- Leather-grained 3-spoke steering wheel
- Electrically adjustable and heated outside rearview mirrors, L & R.
- Vanity mirror in sun visor
- Three speakers and antenna
- Transistorized tachometer
- Trip mileage odometer

## 924

## 924 Turbo

## Chassis suspension

Unitized construction	Independent coil/shock absorber struts, negative steering roll radius	Independent coil/shock absorber struts, negative steering roll radius
Front suspension		
Rear suspension	Independent trailing—diagonal arm, one torsion bar each	Independent trailing—diagonal arm, one torsion bar each
Shock absorbers	Double acting hydraulic shock absorbers, front and rear	Double acting hydraulic shock absorbers, front and rear
Stabilizer	Front 20 mm	Front 20 mm
Service brake	Dual diagonal circuits, power assist, discs, front—drums, rear	Dual diagonal circuits, power assist, vented discs, front and rear
Wheel rims	6 J x 14—light alloy	6 J x 15—light alloy
Tire size	185/70 HR 14	185/70 VR 15
Steering	Rock and pinion	Rock and pinion

## Capacities

Engine	5.3 U.S. qt. (5.0 ltr.)	5.8 U.S. qt. (5.5 ltr.)
Transmission	2.7 U.S. qt. (2.6 ltr.)	2.7 U.S. qt. (2.6 ltr.)
Fuel tank	17.4 U.S. gal. (66 ltr.)	17.4 U.S. gal. (66 ltr.)
Windshield washer tank	6.7 U.S. qt. (6.4 ltr.)	6.9 U.S. qt. (6.5 ltr.)

## Dimensions

Wheel base	94.5 in. (2400 mm)	94.5 in. (2400 mm)
Track, front	55.9 in. (1418 mm)	55.9 in. (1418 mm)
Track, rear	54.0 in. (1372 mm)	54.9 in. (1394 mm)
Length	170.1 in. (4320 mm)	170.1 in. (4320 mm)
Width	66.3 in. (1685 mm)	66.3 in. (1685 mm)
Height (unladen)	50.0 in. (1270 mm)	50.2 in. (1275 mm)
Ground clearance at max. load	4.9 in. (125 mm)	4.9 in. (125 mm)
Turning circle—curb to curb	30.2 ft. (9.2 m)	30.2 ft. (9.2 m)

## Weight

Permissible gross weight (preliminary)	3307 lbs. (1500 kg)	3418 lbs. (1550 kg)
--	---------------------	---------------------

## Performance

Top speed mph. (km/h)	120 (192)	134 (215)
Acceleration 0–60 mph.	10.8 sec.	9.0 sec.
Fuel Consumption*	20 estimated mpg, 35 estimated highway (man.) 21 estimated mpg, 28 estimated highway (auto.)	20 estimated mpg, 33 estimated highway

\*1982 EPA estimates. Compare these estimates to the “estimated mpg” of other cars. Your actual mileage will vary with speed, weather, and trip length. Highway mpg will probably be less.

- Quartz clock
  - Electric windshield wiper with intermittent wipe cycle
  - Retractable Halogen headlamps
- In addition to all the above, the 924 Turbo has the following standard appointments:

- Digital ignition; Two fuel pumps; Oil cooler; Heavy-duty clutch
- 4-wheel ventilated disc brakes
- Light alloy wheels, 5-bolt (185/70VR15 tires)
- Leather-covered steering wheel
- Rear spoiler
- Rocker panel molding

### Porsche 924 Options: Customizing your Porsche the Porsche Way.

A wide range of options is available to help you personalize your 924. Some of the choices have already been mentioned, such as the Porsche palette of body and interior colors. A removable roof. The following is a listing of additional options and accessories available for Porsche 924:

- Digital cassette radio
- Leather-covered 3-spoke steering wheel
- Automatic transmission
- Limited slip differential

- Spoke-type alloy wheels (4-bolt)
- Leather or Berber cloth sport seats
- Luggage rack
- Headlamp washers
- Electric rear window wiper
- Power antenna
- Alarm system
- Pressure cast 6J x 15 light alloy rims
- Stabilizer bars—23mm front, 14mm rear, and sport shock absorbers

The Porsche 924 Turbo also sports these additional optional amenities:

- Disc-type forged alloy wheels, 205/55VR16 tires
- Anti-theft device for wheels

Volkswagen of America, Inc. believes the specifications in this brochure to be true at time of printing. However, specifications, standard equipment and options subject to change without notice.

Specifications, standard equipment and options are subject to change without notice.