



PORSCHE



**The 911 GT2**



# Contents

<b>The 911 GT2</b>	<b>6</b>
<b>Drive</b>	<b>18</b>
<b>Chassis</b>	<b>42</b>
<b>Safety</b>	<b>54</b>
<b>Comfort</b>	<b>66</b>
<b>Environment</b>	<b>82</b>
<b>Personalisation</b>	<b>86</b>
<b>Factory collection</b>	<b>100</b>
<b>Service</b>	<b>102</b>
<b>Summary</b>	<b>104</b>
<b>Technical data</b>	<b>106</b>
<b>Index</b>	<b>108</b>



## The 911 GT2





How do we know our limits?  
Because we choose to  
explore them.

The 911 GT2.

**Always composed. Even in extremes.**

**Engineering the 911 GT2.**

The Porsche 911 GT2. The exception to the rule. Every new edition has clearly exceeded everything that has gone before. Designing a 911 GT2 requires a new approach to old ideas. It means questioning convention, crossing the limits, thinking beyond the norm. It means not being confined to

road or track, straight or bend, comfort or sports performance. It means having the freedom to leave what you know and examine new possibilities. The result: our most powerful road-going 911.

The source of that power is a 3.6-litre flat-six boxer engine

based on the current 911 Turbo. Special features include VarioCam Plus and twin turbochargers with Variable Turbine Geometry (VTG, see page 28) enabling faster response at lower engine speeds. Together, they generate even greater power: a mighty 390 kW (530 hp) at 6,500 rpm. Maximum

torque of 680 Nm is available from 2,200 to 4,500 rpm. At 5,500 rpm, it is still higher than 650 Nm. The benchmark sprint to 100 km/h (62 mph) is completed in 3.7 seconds. Maximum speed is 329 km/h (204 mph).

For some, that number means little on paper – but it all becomes clear on the road. With a driving experience – and an engine sound – that can only be conceived in the Porsche 911 GT2. Performance

and efficiency have both been improved, mainly through changes to the turbocharging system. The flow-optimised turbines and compressor units have been specially adapted to the engine output and offer a more effective turbocharging process.

In addition, an expansion intake system has been specially developed for the 911 GT2 (see page 32) which overturns all previous principles of air supply to turbo

engines. Equally effective is the new rear silencer, now made from ultra-lightweight titanium.

In the end, even we were impressed with the power of the 911 GT2, as we had not expected that so much potential existed in the engine of the 911 Turbo from which it is derived. This was achieved because, in terms of development, we were prepared to go down new, previously unexplored avenues.

Drive is transmitted through a precision six-speed manual gearbox. Rear-wheel drive provides driving dynamics that are similar to those of a racing car. In the 911 GT2, Porsche also uses a special system for conventional manual transmission: the Launch Assistant (see page 38) – for maximum acceleration from a standing start.

For a sporty but still comfortable drive, particularly for this type of sports car, the standard suspension features variable damping provided

by Porsche Active Suspension Management (PASM, see page 48).

This active damping system offers a wide range of benefits including greater performance and comfort.

Also standard is Porsche Stability Management (PSM, see page 50). For the first time, the integrated control systems for lateral and longitudinal dynamics, stability control (SC) and traction control (TC) can be fully disabled in two stages for a more natural drive. This means the

car can also be enjoyed to maximum effect on the racetrack.

The one-piece 19-inch GT2 alloy wheels of the 911 GT2 are fitted with road-legal sports tyres as standard. In size 325/30 ZR 19 on the rear, these are 20 mm larger than on the 911 Turbo. The special tread and compound enable tremendous lateral acceleration and higher cornering speeds as well as precision handling and turn-in characteristics on either road or racetrack. A range of

setup options is available for racing use, including ride height, camber, toe angle and front/rear anti-roll bars.

Developed in motorsport, and standard on the 911 GT2 is the Porsche Ceramic Composite Brake (PCCB, see page 58). The discs are made from specially treated carbon fibre and are approximately 50% lighter than comparable metal alternatives. The results: better brake perfor-

mance, greater agility and lower fuel consumption.

Sports bucket seats (see page 72) with folding backrest, integral thorax airbag and manual fore/aft adjustment, are fitted as standard. A perfect driving position is essential in a car with the performance potential of the 911 GT2. The latest Porsche Communication Management (PCM, see page 76) is also fitted as standard. This features a new 6.5-inch touchscreen for intuitive control.

We believe that you don't have to exploit the full potential of the 911 GT2. But you may well choose to.





**Aesthetically. Aerodynamically. Resistance is futile.**

**Designing the 911 GT2.**

Power. Torque. Acceleration. All in plentiful supply. Nothing else can match that energy – except the car’s design. A single glance is all it takes to realise that fact.

The front end is aerodynamically adapted for the high thermal load of the engine and increased

braking power, with large air intakes for improved air flow to the central radiator and front brakes. The integral air outlet ahead of the front lid makes a major contribution to front-end downforce. The airstream from the central radiator is channelled up over the car, forcing the front end

downwards, thereby enhancing balance and steering response.

The importance of air in the performance of the 911 GT2 is also apparent from the large intake openings in the rear side panels which supply the intercooler units.

The most impressive view is also the one that others will see most of all: the rear. The fixed rear wing with integral lip spoiler ensures optimum stability at speed.

As the car accelerates and you’re pressed into your seat, air is forced through the intake openings on the rear wing uprights and into the engine turbocharging system. This ‘ram air’ effect has a key role to play in the exceptional efficiency of the engine. Since air is already

being forced into the turbos, there is less resistance from the compressors and therefore less back-pressure in the exhaust, which means greater engine performance.

The engine cover, featuring the GT2 logo, is made from lightweight glass-fibre reinforced plastic (GRP). Twin titanium tailpipes are elegantly incorporated within the rear apron design. Warm air is vented from the

engine compartment via cooling slits at the rear.

The combined effect of all these aerodynamic modifications is a drag coefficient of just 0.32 as well as positive front and rear downforce. Behind the wheel, that means better grip, better directional stability and exceptional handling characteristics. Technically and visually, the result is the same: a breathtaking driving machine.



## Drive

For some, the aim is  
high performance.  
For us, that's merely the result.



3.6-litre twin-turbo boxer engine

**The greatest strength comes from within.**

**Engine.**

At Porsche, our aim is not to increase power – except through increased efficiency. Which is why we began with the 911 Turbo when developing an engine for the 911 GT2. Its power is combined with rear-wheel drive for racing-car driving dynamics. But how is it possible to improve on

an engine that is already so close to perfection? How did we introduce even greater potential – and the character of a racing engine? The answer: by increasing efficiency. This was mainly achieved by four crucial components, one of these being the six-cylinder twin-turbo

boxer unit with flow-optimised turbines featuring Variable Turbine Geometry (VTG, see page 28) and larger compressors on the intake side. Together with VarioCam Plus (see page 26), they boost performance while reducing emissions over the entire engine speed range. Also with the

innovative expansion intake system which works on highly efficient principles that are contrary to all previous methods (see page 32). In addition, the new lightweight rear silencer made from titanium enhances performance by producing less back-pressure through the exhaust system.

Oil is evenly distributed under all load conditions (e.g., high-speed cornering) thanks to a dry-sump lubrication system with external tank. After passing through the engine, the oil is cooled by means of a dedicated oil-water heat exchanger. Both of these systems are proven in competition use.

The water-cooled flat-six twin-turbo engine with four-valve technology in the rear of the 911 GT2 generates a mighty 390 kW (530 hp) from a 3.6-litre displacement at 6,500 rpm.

Maximum torque of 680 Nm is achieved at low rpm and sustained across much of the engine speed range. It is available between 2,200 and 4,500 rpm and the resulting acceleration is quite literally breathtaking.

The benchmark sprint to 100 km/h (62 mph) is completed in 3.7 seconds; 200 km/h (124 mph) requires just 11.2 seconds. Maximum speed – if you really want to put it to the test – is 329 km/h (204 mph). Even more impressive is the power-to-weight ratio of 361 hp per tonne and the specific power output of 147 hp per litre. Fuel economy is also exceptional for a car with such high performance.

There is nothing ordinary about the 911 GT2 and it exceeds even the highest expectations. In other words: everything you'd expect from the most powerful road-going 911.

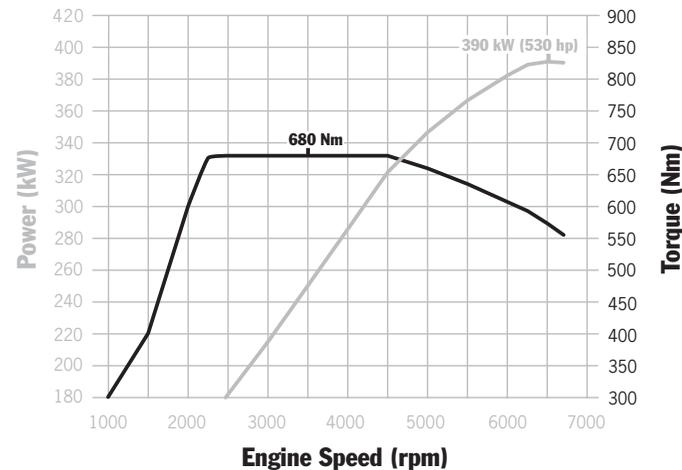

911 GT2: 680 Nm from 2,200 to 4,500 rpm, 390 kW (530 hp) at 6,500 rpm

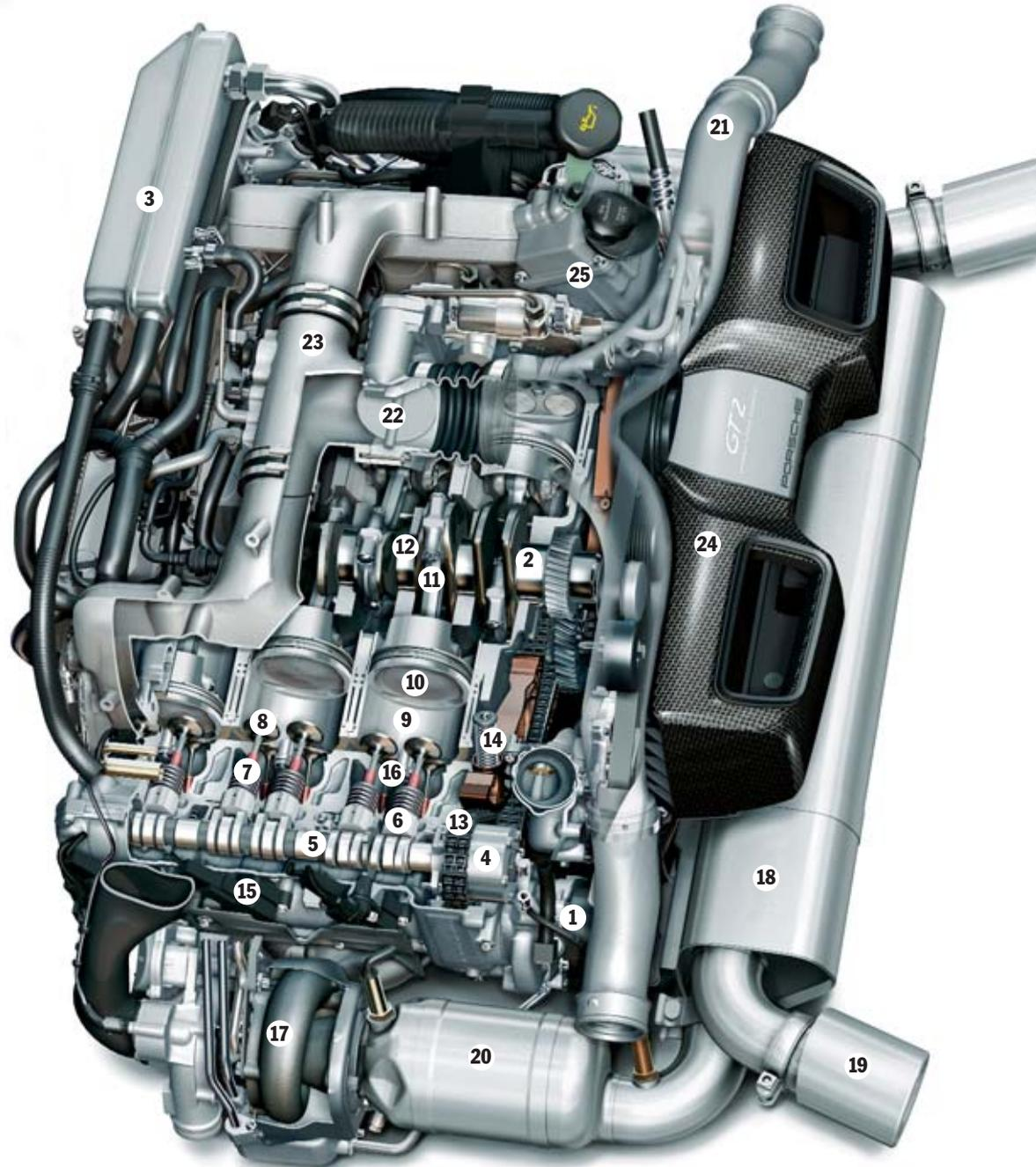

1. Oil scavenge pump
2. Oil-pressure pump (obscured)
3. Engine oil reservoir (dry-sump lubrication)
4. Camshaft adjuster (VarioCam Plus)
5. Intake camshaft
6. Tappets with hydraulic valve clearance adjustment
7. Valve springs
8. Valves
9. Nikasil-coated cylinder bore
10. Forged aluminium piston
11. Forged connecting rod
12. Crankshaft
13. Camshaft drive chain
14. Camshaft drive chain tensioner with guide rail
15. Single-spark ignition coil
16. Spark plug
17. Exhaust-gas turbocharger with Variable Turbine Geometry (VTG)
18. Main silencer (titanium)
19. Tailpipe (titanium)
20. Catalytic converter
21. Pressure pipe
22. Throttle valve (electronically actuated)
23. Expansion intake manifold
24. Air filter
25. Fluid reservoir for power-steering system



### Lightweight design.

The six-cylinder twin-turbo boxer engine is a compact unit offering excellent cylinder charging and torque-curve characteristics as well as first-rate balance with minimal vibration. The flat-six design allows a low centre of gravity with resulting advantages for traction and driving dynamics. The alloy crankcase consists of two main sections, each containing one bank of cylinders. The

crankshaft runs in eight main bearings and is driven by forged connecting rods. For optimum strength and durability, we've used forged aluminium pistons running in Nikasil-coated aluminium liners and cooled via individual oil-spray jets. The results: lower frictional resistance and a lengthy service life – even when subjected to heavy use.

The cylinder heads are made from an extremely heat-resistant

lightweight alloy. Each cylinder bank has two overhead camshafts driving a set of four valves (two inlet and two exhaust) on each individual cylinder. The valves are arranged in a 'V' formation and have a highly efficient dual-spring closing action enabling higher engine speeds. Performance is enhanced with the aid of both Variable Turbine Geometry (VTG, see page 28) and VarioCam Plus (variable valve timing and lift on the inlet side). The benefits are

not only greater power and torque, but also better fuel economy and lower emissions.

### Dry-sump lubrication.

This racing technology uses a separate oil reservoir to ensure consistent oil pressures throughout the engine, even during prolonged periods of lateral and longitudinal loads. After passing through the engine, every drop

of oil is returned directly to the external reservoir. The flow is driven by two scavenge pumps in each cylinder head and a further two pumps in the crankcase. Gas is removed from the returning oil via a defoaming device in the reservoir. The oil is returned to the lubrication points in the engine by means of a dedicated oil-feed pump. With a further scavenge pump in each of the twin turbocharger units, the 911 GT2 has a total of nine

separate pumps driving the lubrication system. The oil level can be checked from inside the car via the standard on-board computer.

The 911 GT2 is factory-filled with Mobil 1 high-performance fully synthetic oil. The exceptional properties of this premium-quality lubricant ensure reliable starting even in the coldest conditions. It also reduces wear and contributes to the long-term durability of the engine.

**Engine cooling.**

The engine of the 911 GT2 features cross-flow water cooling with fully integrated coolant management. This technology ensures a consistent flow of coolant to each of the engine's cylinders. Waste heat from the oil is transferred to the coolant via two oil/water heat exchangers. The coolant is routed through twin radiator modules ahead of the front wheels and a centrally placed unit in the nose.

**VarioCam Plus.**

VarioCam Plus is a variable valve timing system on the inlet side which also features two-stage valve lift. The benefits it provides include greater power and torque at all engine speeds, as well as excellent running characteristics, better fuel economy and fewer emissions. Essentially, VarioCam Plus makes two engines out of one. The first is geared for normal road driving, the

second for high-performance use. The system switches seamlessly between the two as the driver inputs change. All operations are controlled by the engine management system. The results: emphatic acceleration and smoother running. The two-stage lift mechanism on each inlet valve consists of an electro-hydraulically switchable tappet. Each of the 12 tappets consists of two concentric parts – an

outer ring and a central shaft – which can be locked together by means of a pin. The system can then vary the valve lift by using two large profile cams on the outer ring or a smaller cam lobe on the central shaft. The timing of each valve is steplessly controlled by means of an electro-hydraulic rotary vane adjuster at the head of the corresponding camshaft. To improve responsiveness during warm-up in cold weather, VarioCam Plus will select the higher valve lift setting and retard valve timing.

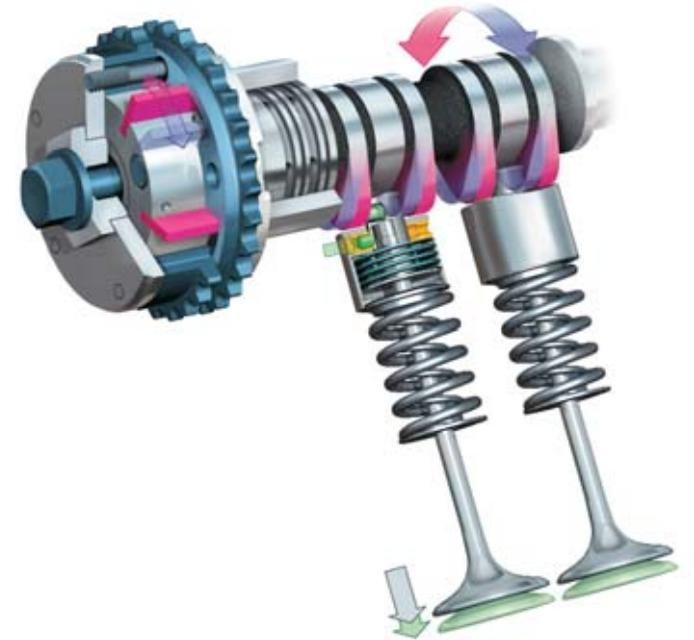

VarioCam Plus

At medium revs and low engine loads, the lower valve lift setting is activated and timing advanced in order to reduce fuel consumption and emissions. The economy of the engine is particularly enhanced at lower engine speeds. For maximum power and torque, the higher lift setting is selected and the timing of the valves is advanced.

This results in copious torque and exceptional fuel economy, particularly in comparison with much larger engines offering similar power output.





Turbocharger with Variable Turbine Geometry (VTG)

**Breathe easy – when holding your breath.**

**Variable Turbine Geometry (VTG).**

Porsche has a long and celebrated tradition of using turbocharged power on both road and track. On the 911 GT2, we've enhanced this technology with Variable Turbine Geometry (VTG).

On a conventional turbocharger, the exhaust flow drives a turbine that is connected to a compressor on the intake side. By compressing the incoming air, the amount of oxygen in a given volume is increased. Since compression

also causes an increase in temperature, the air must be cooled in a device known as an 'intercooler'. With more oxygen present in each cylinder charge, more fuel can be burnt, yielding greater energy. Since higher

exhaust pressures generate greater loads on the intake side, the intake pressure must be carefully controlled in order to protect the engine. This 'boost pressure' is limited using 'wastegate' valves that bypass excess pressure around the turbine.

Another important factor in the system is the size of the turbocharger. Since a smaller

turbine has a lower mass, it responds more quickly to increasing pressure, spinning up easily to its optimum speed. The key disadvantage of using a smaller turbo is that the back-pressure generated at higher engine speeds causes a significant reduction in performance. Resistance is caused by the smaller cross-sectional area through which the exhaust is required to flow.

Larger turbo units, which create lower back-pressure at higher rpm, take considerably longer to spin up under power due to the large cross-sectional area and relative inertia of the heavier turbine. Generally, this type of turbo will only be effective in the medium rpm range. This phenomenon, known as 'turbo lag', means there is virtually no turbocharging effect at lower engine speeds.

To overcome this problem, the twin water-cooled turbochargers on the 911 GT2 feature Variable Turbine Geometry (VTG). With this technology, the gas-flow from the engine is channelled onto the turbines via electronically adjustable guide vanes. By changing the vane angle, the system can replicate the geometry in all types of turbo, large or small, and thus achieve the optimum gas-flow characteristics. The guide vanes are controlled by the engine management system. The result is a high turbine speed – and therefore higher boost pressure – even at low engine rpm. With more air available, the combustion is increased, yielding greater power and torque.

Special features on the 911 GT2 include flow-optimised turbines and larger compressors which generate a higher boost pressure. Maximum torque is achieved at low rpm and sustained across much of the engine speed range.

With 680 Nm available between 2,200 and 4,500 rpm, the resulting acceleration is nothing less than phenomenal.

When the boost pressure reaches its maximum value, the guide vanes are opened further. By varying the vane angle, it is possible to generate the required boost pressure at all engine speeds. As a result, there is no need for excess pressure valves

on the intake side as found on conventional turbocharged engines.

This delivers impressive engine efficiency and lower fuel consumption.



Guide vanes closed

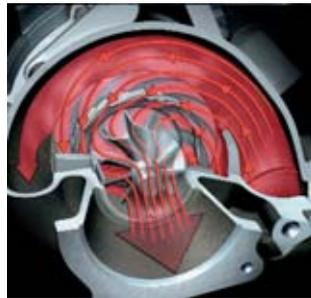

Guide vanes closed



Guide vanes open

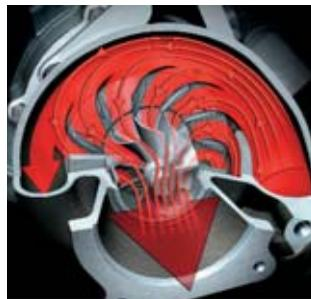

Guide vanes open

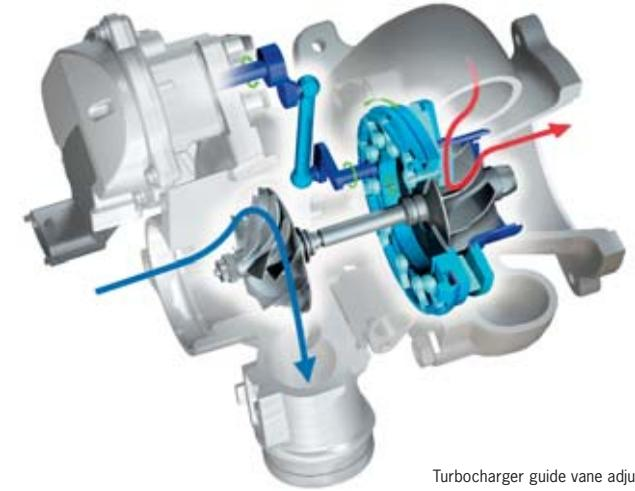

Turbocharger guide vane adjuster

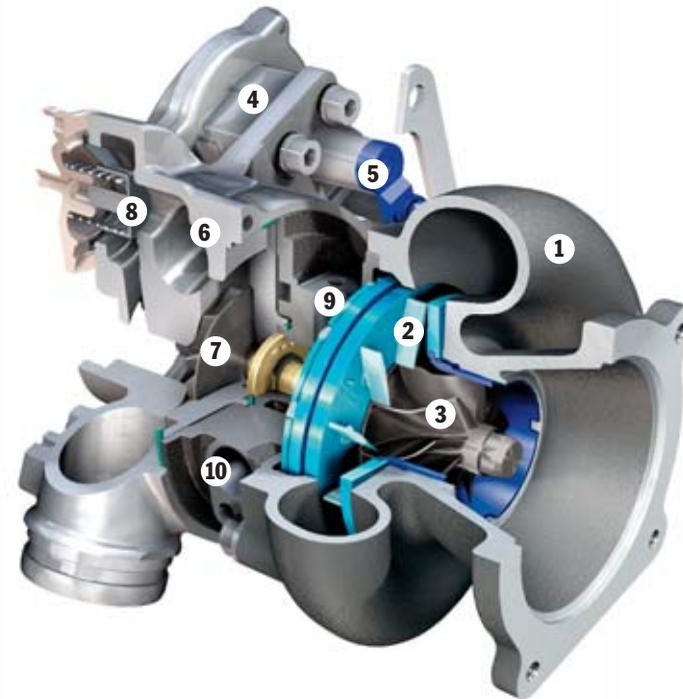

1. Turbine casing
2. Movable guide vanes
3. Turbine wheel
4. Electric motor for guide vane adjustment
5. Guide vane adjuster
6. Compressor casing
7. Compressor wheel
8. Recirculation valve
9. Oil inlet
10. Coolant inlet



Expansion intake manifold

**Expansion intake manifold.**

More power than a 911 Turbo – from the same engine? Not easy. But feasible, which is why it required yet another spectacular innovation from Porsche.

The 911 GT2 has an innovative expansion intake system with a unique working principle which overturns the methods previously used. Our ‘expansion’ intake manifold is a radical new development

that is the polar opposite of the resonance principle used on conventional turbocharged engines.

A resonance manifold increases engine output by forcing additional air into the combustion chambers. To do this, the manifold is designed in such a way that the air – which vibrates due to the action of the valves – is in a compression phase as it passes through the inlet ports.

Unfortunately, compression not only increases air volume, it also increases air temperature and this has a negative effect on ignition.

Our new expansion manifold simply turns that principle around. The internal geometry is radically different from that on a resonance intake system. Key modifications include a longer distributor pipe, with a smaller diameter, and shorter intake pipes.



As a result, the air is in the expansion phase as it enters the combustion chambers. Since expansion always cools, the air/fuel temperature is lower and ignition is significantly improved – thereby increasing performance.

Of course, the amount of air that enters the engine under expansion is less than it would be under compression. To compensate for this, we’ve simply increased the boost pressure

from the turbochargers by approximately 0.2 bar. The resulting increase in temperature – again through compression – is immediately offset by the updated intercoolers.

Instead of hot compressed air entering the combustion chambers, we now have cooler air generating more power and torque. As a consequence, there is a major improvement in engine efficiency and therefore

lower fuel consumption even under heavy loads and at high rpm.

A simple solution, but then that’s often the way when you take a new approach to old ideas.



Exhaust system

### Exhaust system.

The rear silencer and tailpipes of the 911 GT2 are made from ultra-lightweight titanium to reduce the weight on the rear axle, and improve driving dynamics. The exhaust leaves the engine through high-performance manifolds into separate tracts for each of the two banks of cylinders. Twin three-way catalytic converters clean the two streams before they converge in the main silencer unit. The twin titanium

tailpipes are fully integrated within the rear apron moulding. Large-diameter tubes reduce back-pressure on the engine, thereby increasing performance. The catalytic converters are close to the engine, enabling faster warm-up and therefore improving efficiency. When starting from cold, the process is assisted by a secondary air injection system.

A system of 'Lambda' or oxygen sensors in each of the exhausts provides continuous monitoring

of engine efficiency. Data supplied by one pair of sensors enables the engine management system to perform separate adjustment of the air/fuel mix for each bank of cylinders. A further pair of sensors\*, one on each tract, is used to monitor the efficiency of the respective catalytic converter. This facility enables much more accurate control of potentially harmful emissions.

\* Not in markets with leaded fuel.



The exhaust system on the 911 GT2 produces a warm, deep and bass-rich sound – even when the engine is idling.

### Fuel system.

Fuel is supplied to each of the six cylinders using a sequential fuel injection system. The timing of each injection and the volume supplied to each bank of cylinders are controlled by the engine management system. Adjustments

are based on a range of variables, including throttle position, engine speed, boost pressure, coolant temperature and exhaust gas composition. The results are optimised

A hot-film air mass sensor monitors the volume and density of the incoming air to ensure the best possible air/fuel mix, regardless of weather and altitude.

### Ignition system.

The 911 GT2 features static high-voltage ignition technology. Separate coils on each of the plugs with platinum electrodes ensure perfect ignition every time. The role of distributor is performed by the engine management system, which controls the individual spark plugs directly, for optimum performance and minimum fuel consumption.

**Engine management system.**

The Motronic ME7.8.1 engine management system facilitates optimum performance at all times. This high-precision ECU controls all engine-related functions and assemblies (see diagram), such as Variable Turbine Geometry, VarioCam Plus and the electronic throttle, one of the key prerequisites for the standard Porsche Stability Management (PSM). This produces various

benefits, such as optimum economy, emissions and performance in all driving scenarios.

One of the most important tasks performed by the engine management system is cylinder-specific knock control. By preventing pre-ignition at high engine speeds and loads, this function can avert costly damage to the pistons and cylinders. Since temperatures tend to vary across the engine, each cylinder is monitored

separately. If a risk is detected, the individual ignition timing is adjusted.

The on-board diagnostics system, designed to European standard, quickly detects any faults in the exhaust and fuel system and displays them during driving via the car's instruments. The benefits include active prevention of harmful emissions as well as consistent rates of fuel consumption.



**Input data**

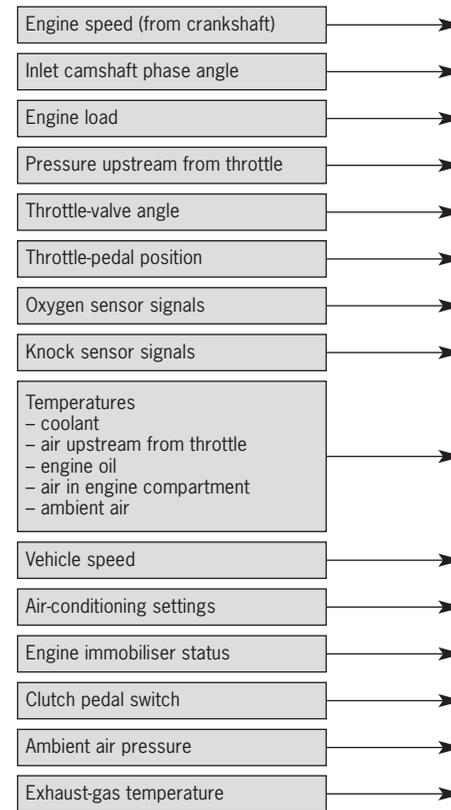

**Used to regulate/control**

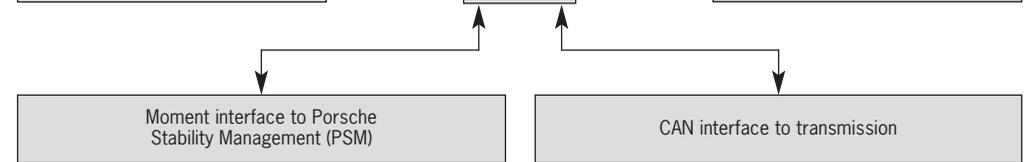
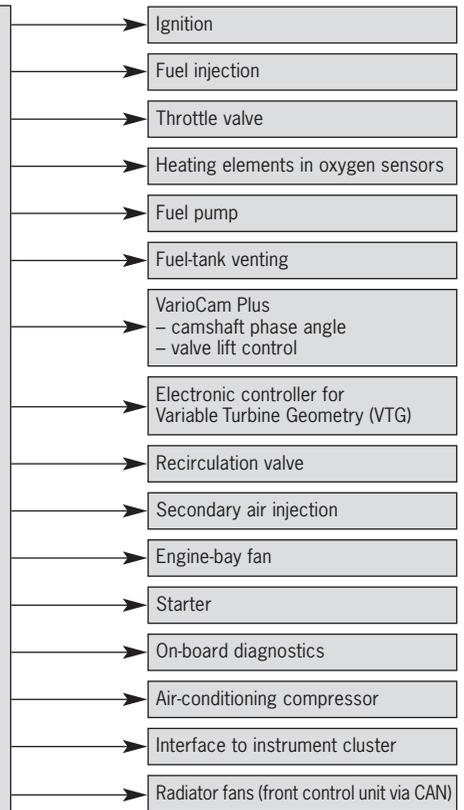



**Maximum response to minimum effort.**

**Transmission.**

The six-speed manual gearbox in the 911 GT2 is specifically designed for the high engine performance. The individual ratios are carefully matched to the specific characteristics of the engine.

The gear-lever throw is short and precise, enabling fast and accurate gearshifts.

A typical feature of the 911 GT2 is the Launch Assistant – for

maximum acceleration from a standing start. The clutch and accelerator are depressed when the vehicle is stationary. When a boost pressure of approximately 0.9 bar is displayed in the instru-

ment cluster, release the clutch as quickly as possible and maximum acceleration automatically ensues.

Normally on a turbocharged vehicle with manual gearbox, the boost pressure under acceleration from a standing start is relatively low. The turbo effect is delayed as the engine gathers speed and the boost pressure starts to build.

On the 911 GT2, this initial delay is reduced. While the car is still stationary, the fuel injection is modified to help the engine reach maximum output earlier. The boost pressure is significantly increased and the engine readied for a faster start.

A specially designed traction control system adapts the acceleration procedure automatically in the ECU to ensure optimum traction. The clutch remains engaged. This reduces load and prevents high clutch wear. The power is transmitted directly to the road via the rear axle.

The gearbox is combined with a cable linkage and dual-mass fly-wheel offering added comfort and precision. The close ratio spread enables powerful acceleration within the optimum engine power band.

Steel baulk rings on gears two to five ensure a precise gearshift action even under extreme loads.

Cooling is provided by an additional oil-to-water heat exchanger and spray lubrication. Both of these features are essential for durability in endurance racing conditions.

Other standard features include a limited-slip differential with asymmetrical lock factor. Offering better traction and handling when exiting a corner, it applies a higher proportion of drive torque to the loaded outer rear wheel.

The term ‘asymmetrical’ means that one lock factor is applied when cornering under power (28%), and another when braking for a corner (40%).



- 1. Bi-Xenon headlights
- 2. Radiator module (left)
- 3. Radiator module (centre)
- 4. Radiator module (right)
- 5. Coolant pipe

- 6. Coolant expansion tank
- 7. Air filter
- 8. Exhaust-gas turbocharger with Variable Turbine Geometry (VTG)

- 9. Intercoolers
- 10. Pressure pipe
- 11. Throttle valve (electronically actuated)
- 12. Expansion intake manifold

- 13. Main silencer (titanium)
- 14. Tailpipe (titanium)
- 15. Oil filter
- 16. Engine oil reservoir (dry-sump lubrication)

- 17. Generator
- 18. PASM damper
- 19. PCCB brake
- 20. Tandem brake booster

- 21. 6-speed manual gearbox
- 22. Sport bucket seat



## Chassis

An extraordinary car with everyday capability.

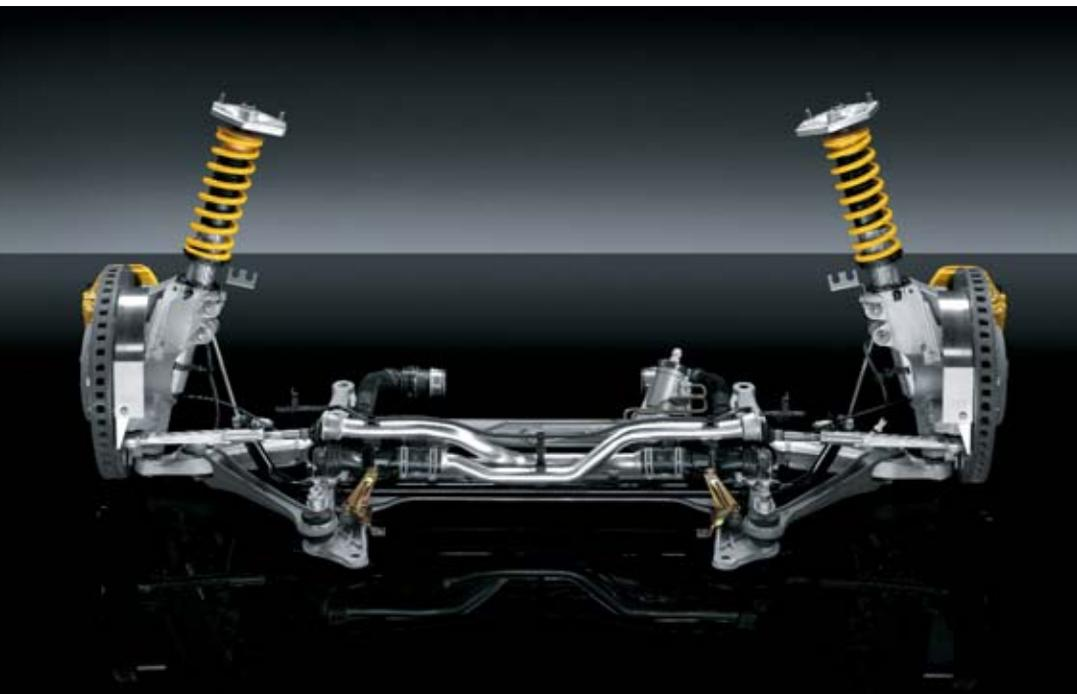

Front axle

## Racetrack. Motorway. Wherever the road goes.

### Chassis.

The 911 GT2 chassis is designed for racecar-like performance on every type of tarmac from motorway to track. The car rides about 25 mm lower than the 911 Carrera and its lightweight build has reduced overall weight as well as the unsprung masses. Agile and responsive, it is stable and secure

– particularly during cornering manoeuvres.

The front suspension with its special wheel mounts has McPherson spring struts with the wheels mounted individually on trailing arms and wishbones. Each front wheel is precisely

located, ensuring excellent handling and directional stability in all road and track scenarios.

Brake spoiler elements provide efficient cooling for each of the front brake units.

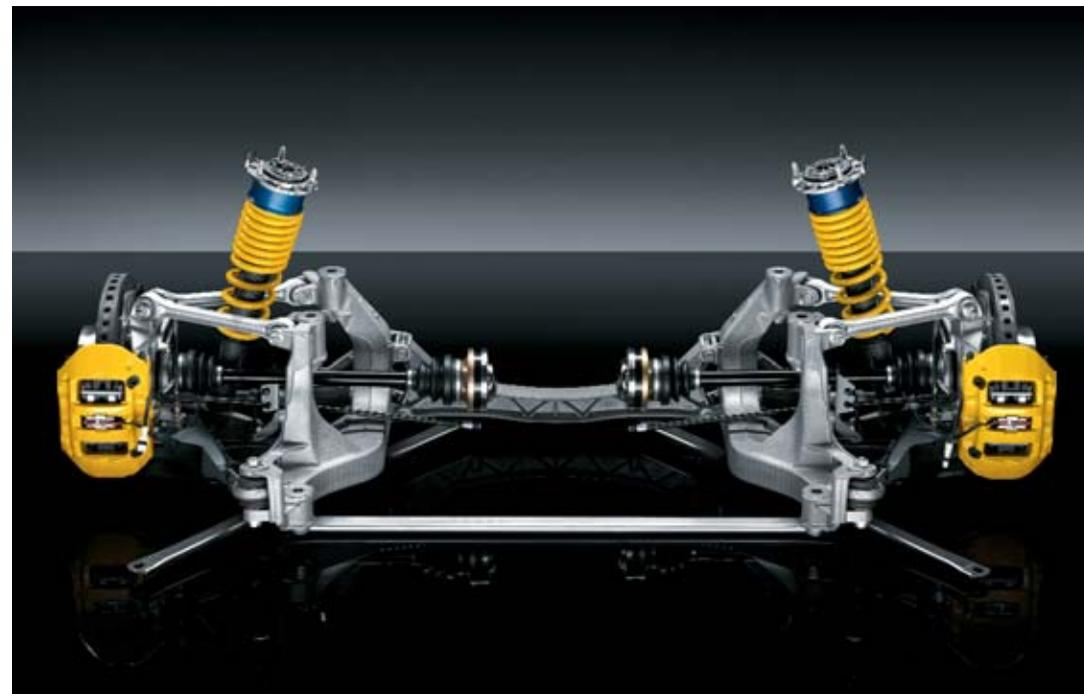

Rear axle

The rear axle assembly consists of subframe-mounted multi-link suspension featuring LSA construction (Light, Stable, Agile). This lightened design featuring an aluminium cross-member is an important factor in the exceptional dynamics of the car.

Ride height, camber, toe angle and anti-roll bar settings can all be adapted to individual circuit characteristics, as befits a racing Porsche.

There is virtually no unwanted movement between the suspension and body, thanks to special features such as metal bearings with ball joints on the front strut mounts and rigid cross-members at the rear. This reduced elasticity and improved wheel location enable better handling and turn-in.

The 911 GT2 has an electronic variable damping system as standard – Porsche Active

Suspension Management (PASM, see page 48). This variable damper system offers two basic setup modes, 'Normal' and 'Sport'.

**Less weight. More road contact.**

**Wheels.**

The 911 GT2 runs on one-piece 19-inch GT2 wheels with anti-theft protection and wheel centre caps featuring the GT2 logo. The wheels are extremely light for their size due to their special lightweight construction.

The resulting reduction in unsprung masses improves driving dynamics and performance. Thanks to the generous internal diameter of the wheel, large brakes can be fitted on the front axle. The wheels run flush with the exterior of the car

and come with special sport tyres as standard.

The wheel dimensions are 8.5J x 19 ET 53 with 235/35 ZR 19 tyres (front) and 12J x 19 ET 51 with 325/30 ZR 19 tyres (rear).

The 19-inch sports tyres provide a large road contact patch. They offer greater traction under acceleration and braking, greater precision in both handling and manoeuvrability, as well as higher cornering speeds on dry road surfaces. In short: even greater driving pleasure. Note: increased risk of aquaplaning due to lower tread profile.

Tyre Pressure Monitoring (TPM), included as standard equipment, provides early warning of tyre pressure loss. The driver is informed via the on-board computer display as well as a separate indicator light. A tyre repair system consisting of tyre sealant and compressor with separate tyre pressure gauge is also standard.



19-inch GT2 wheel



## Redefining 'normal'.

### Porsche Active Suspension Management (PASM).

The 911 GT2 is fitted with Porsche Active Suspension Management (PASM), an electronic damper adjustment system. This active damping system offers continuous adjustment of individual damping forces based on current road conditions and driving style.

The driver can choose from two basic setup modes: 'Normal' and 'Sport'. 'Normal' mode is designed for general road driving and wet circuit use. 'Sport' mode enables greater lateral acceleration and increases traction on the race-track.

In either mode, the system responds to changing loads by automatically applying the optimum rate on each individual damper from a range of predefined options.

Various sensors are used to monitor the movement of the body during acceleration, braking and cornering manoeuvres, as well as on poor road surfaces. The PASM control unit then evaluates this data and modifies the damping force on each individual wheel in accordance with the selected mode. The results are a reduction in pitch and roll as well as consistent road contact on all four wheels.

If 'Sport' mode is selected using the PASM button identified by a damper symbol, the suspension is set to a harder damper rating that is specially designed for performance driving. If the quality of the road surface falls below a certain threshold, the system immediately

changes to a softer rating within the 'Sport' setup range. This adjustment enhances occupant comfort as well as traction and grip. When the road surface improves, PASM automatically reverts to the original, harder rating.

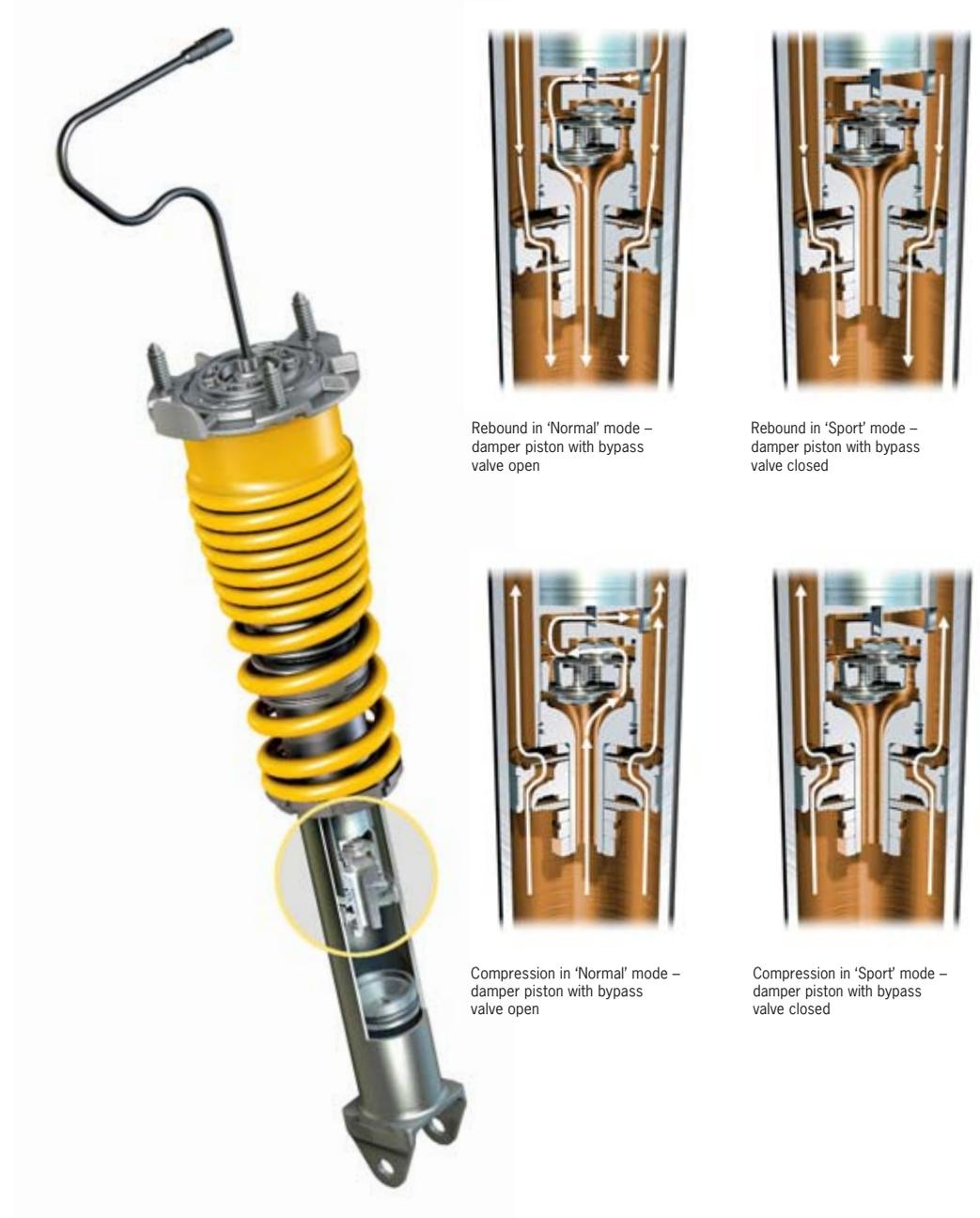

Rebound in 'Normal' mode – damper piston with bypass valve open

Rebound in 'Sport' mode – damper piston with bypass valve closed

Compression in 'Normal' mode – damper piston with bypass valve open

Compression in 'Sport' mode – damper piston with bypass valve closed



**It's good to know who's in control.**

**Porsche Stability Management (PSM).**

Some things never change, including driver expectations of a 911 GT2: sports-oriented performance, a direct response and impressive power.

So Porsche Stability Management (PSM) has been specially adapted

for the 911 GT2. In addition to ABS, the package includes two automatic driver aids: stability control (SC) and traction control (TC).

Stability control (SC), which is responsible for lateral dynamics,

uses a range of sensors to monitor the direction, speed, yaw velocity (speed of rotation around the vertical axis) and lateral acceleration of the car. Using this information, it is possible to calculate the actual direction of travel at any given moment. If the

car begins to oversteer or understeer, selective braking is applied on individual wheels to restore control in critical driving scenarios.

Traction control (TC), with its integrated ABD (automatic brake differential), ASR (anti-slip regulation) and EDC (engine drag-torque control) functions, is responsible for the longitudinal dynamics of the car. Configured for sports-oriented driving, traction control improves

handling under acceleration on surfaces with inconsistent grip. It also prevents the rear from 'stepping out' if a wheel loses traction under full power. The trigger threshold is relatively high, which means it is rarely employed in normal dry conditions.

A unique feature of PSM on the 911 GT2 is that the control interventions are delayed and can be disabled completely in two stages – for deliberate performance handling.

Stage 1 disables the stability control (SC) via the 'SC OFF' switch in the centre console. In 'SC OFF' mode, the control system does not intervene if the car goes off-course in the lateral direction, which means the throttle can be used to help steer the car.

Traction control (TC) is still active in this mode.

Stage 2 disables the traction control as well via the separate 'SC+TC OFF' switch, giving the driver full command of the vehicle. Another unique feature

is the fact that stability control remains disabled in stages 1 and 2 even when the ABS is required under braking. Specially developed for the 911 GT2, this revised system strategy means the car can also be enjoyed to maximum effect on the racetrack.

The anti-lock braking system (ABS 8.0) is integrated in PSM and remains active, irrespective of which settings have been selected. ABS ensures a relatively short braking distance and thus enhanced safety.

**Maximum precision, however powerful the performance.**

**Steering.**

The steering system is extremely direct and provides detailed feedback from the road. This high level of precision is very advantageous in both racing and normal road use. Thanks to the precise front-axle kinematics and

the variable steering ratio, the car responds to every movement of the wheel.

An important feature of the steering system is the variable ratio gearing. Around the

straight-ahead position, the ratio is less direct, enabling smoother manoeuvres, such as during motorway driving. There is less risk of excessive steering intervention destabilising the car at high speed. Naturally, the system

provides excellent feedback as well as the usual agility. As the wheel is turned harder, the ratio becomes more direct and the steering more responsive. This variability is particularly beneficial in low-speed hairpin bends. The energy-absorbing steering column is a key safety feature since, in the event of a front-end impact, it enables a deformation path of 100 mm.

The intermediate steering shaft is made from aluminium, while the protective tube and steering lock housing are die-cast magnesium.

The standard three-spoke GT2 steering wheel features manual height and reach adjustment. Used in conjunction with the seat adjustment options, it enables every driver to find the ideal seating position.





**Safety**

Uncompromising performance  
is nothing without safety.



Bi-Xenon headlights

**A must: absolute confidence in the safety of your car.**

**Active safety.**

The 911 GT2 excels in every respect, be it power, driving dynamics or safety. Every aspect of its lighting concept, braking system, rigid body and ergonomic interior is fine-tuned to its performance and to the individual driver. For example, the sport

bucket seats (see page 72) with folding backrest offer racecar-like lateral support.

**Lighting system.**

The standard lighting system on the 911 GT2 uses the latest Bi-Xenon gas-discharge technology to achieve a light quality similar to daylight. The compact main headlights provide a broad and



High-level third brake light

uniform swathe of light that increases active safety in all road scenarios and in long, blind corners in particular.

The brightness of the gas-discharge system featured in the Bi-Xenon headlights is approximately double that of conventional halogen units. A headlight cleaning system is also included as standard.

The horizontal indicators in the outer front air intakes use high-performance light-emitting diodes (LEDs) to increase brightness and visibility.

The high-level third brake light at the base of the rear screen is equipped with rapid-response LEDs.

Two additional lights on the inside of each door offer added convenience and safety. The kerb light (white) provides useful illumination when stepping out of the car.

The safety light (red) warns traffic approaching from the rear when the door is open.



**When it comes to brake technology, we demand nothing but the best.**

**Porsche Ceramic Composite Brake (PCCB).**

The 911 GT2 is equipped as standard with the Porsche Ceramic Composite Brake (PCCB) that has already demonstrated its performance credentials on the racetrack, for example, in the vehicles of the Porsche Mobil 1 Supercup.

The large disc diameter (380 mm front and 350 mm rear) adds significantly to brake performance. The ceramic discs are made from a specially treated carbon-fibre compound that is silicated in a high-vacuum process at 1,700 °C. The material thus produced is not

only much harder than metal, it is also more resistant to heat. Even at high temperatures, the thermal resistance of the PCCB disc ensures exemplary dimensional stability. The ceramic material is totally resistant to

corrosion and offers excellent acoustic damping properties.

The pads are mounted in six-piston monobloc aluminium fixed calipers at the front, with four-piston units at the rear. The resulting brake forces are not only extremely high, they are also exceptionally consistent. The pedal response is fast and precise with only moderate input required.

PCCB enables shorter braking distances in even the toughest road and race conditions. Excellent fade resistance ensures greater balance when slowing from racetrack speeds.

The key advantage of PCCB is the total weight saving of approximately 50% over comparable metal discs. The mounting bells on both front discs are made from weight-saving aluminium. As well as enhancing performance and fuel economy, there is a major reduction in both the unsprung and rotating masses. This, of course, improves comfort and road-holding on uneven road surfaces as well as general handling and agility.

Please note that circuit racing, trackday use and other forms of performance driving can significantly reduce the service life of even the most durable pads and discs. As with conventional high-performance braking systems, we recommend that all brake components be professionally inspected and replaced where necessary after every track event.



Porsche Ceramic Composite Brake (PCCB)

**Intelligent crash technology.**

**Passive safety.**

**Bodyshell structure.**

The 911 GT2 complies with all statutory requirements worldwide in respect of frontal, side, diagonal and rear impact protection.

The reinforced bodyshell contains a highly resilient passenger cell offering exceptional crash protection. At the front of the car, the cell is protected by a patented system of longitudinal and transverse members (1). In the event of an accident, energy is absorbed by three separate load paths, one above the other, which disperse the force of impact and minimise deformation of the passenger cell.

Additional features include an extremely rigid bulkhead cross-member (2) made from super high-strength steel. This element is designed to absorb impact forces from the longitudinal members and thus protect both front footwells. In a minor collision, a system of easily replaceable impact absorbers (3) prevents costly damage to the underlying bodyshell structure.

The reinforced doors (4) make an increased contribution to the overall rigidity of the car. An additional load path (5) is used to

channel energy through the upper part of the shell and thus further protect the passenger cell.

In 1985, we began using super high-strength steel elements inside each door to increase side impact protection. On the 911 GT2, this integral reinforcement is made

from tough yet lightweight aluminium. By increasing the proportion of aluminium alloys and high-strength steel, we've also improved the power-to-weight ratio. In all, approximately 20% of the 911 GT2 is made from aluminium.

Another important but perhaps less obvious safety feature is the high-quality surface protection. More than 30 years ago, we became the first manufacturer in the world to use a hot-dip galvanised steel shell. This exacting process is fundamental to the

legendary durability of our cars. It also ensures a consistently high standard of crash protection, even after many years on the road.

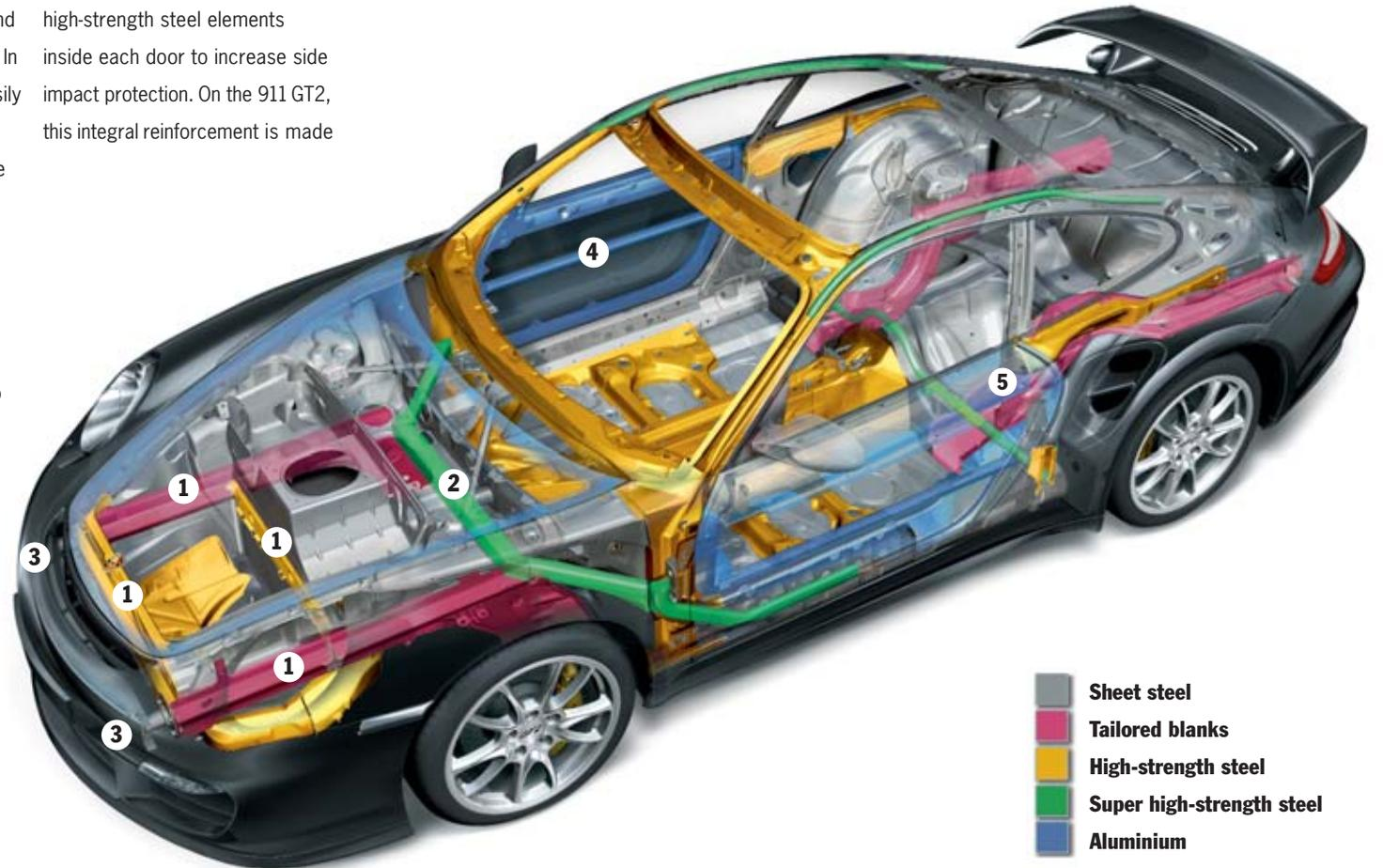

**Airbags.**

The 911 GT2 has a specially developed airbag technology with a total of six airbags. The full-size front airbags have a two-stage inflation function which deploys each airbag separately in accordance with the force and nature of the impact (e.g., frontal or diagonal) before inflating each airbag accordingly. In a low-speed crash, the airbag is only partially inflated, thereby minimising discomfort to the occupants.

The airbag control unit is located in the centre tunnel where it receives additional information from a pair of impact sensors near the headlights. This arrangement allows faster and more accurate crash evaluation and thus better airbag deployment.

**Porsche Side Impact Protection (POSIP).**

The 911 GT2 is equipped as standard with the latest generation of Porsche Side Impact Protection (POSIP). It features two additional airbags for each front seat: a head airbag located in each door and a thorax airbag in the folding

backrest on each of the standard sport bucket seats (see page 72). As well as offering exceptional support, the sport bucket seat provides a much higher level of safety than conventional bucket seat designs.

The thorax and head airbags each have a volume of approximately

eight litres, providing high protection in the event of a side impact. Another important element of POSIP is the side impact protection with door reinforcement.

Other safety features of the 911 GT2 are head restraints that are an integral part of each seat, an energy-absorbing steering

column, three-point seat belts with height adjustment, seat-belt pre-tensioners and force limiters, energy-absorbing elements in the dashboard, and flame-retardant materials throughout the interior.



Porsche Side Impact Protection (POSIP)

**Clubsport package.**

A 'Clubsport' racing package is available as a no-cost option for the 911 GT2, offering

added protection for racetrack use.

Included with the package are a bolt-in rear roll cage behind the

front seats, a six-point racing harness in red for the driver's side, a fire extinguisher with mounting bracket and a preparation for a battery master switch. This is

available separately from the Porsche Motorsport department, as is the front roll cage element required for FIA-approved racing events.

The sport bucket seats with thorax airbags are covered with flame-retardant material.





**Comfort**

Exceeding expectations.  
Comfortably.



## We've demanded your respect. Now have ours.

### Interior.

#### Instruments.

The sporting credentials of the 911 GT2 refer not only to engine and chassis, it also boasts a sporty interior designed around the driver.

A car like the 911 GT2 requires an ergonomically efficient driving environment with unhindered access to all key information. Clearly visible at the centre of the cluster of five instruments

is a large rev counter with GT2 logo and titanium-coloured dial. The needles and markings in the instrument cluster are yellow. For optimum acceleration, you can view the upshift display in

the rev counter. A centrally placed, clearly visible arrow indicates the latest time to change gear.

#### On-board computer.

The integral on-board computer gives information on boost pressure, average fuel consumption, speed, remaining distance and

exterior temperature. It can also be used to view data from the standard Tyre Pressure Monitoring (TPM) as well as the timing system featured in the optional Chrono Package Plus (see page 75). The computer is operated using a control stalk on the steering column, with information displayed in the instrument cluster.

Other standard features include automatic air conditioning with active carbon filter.



**Interior materials.**

The high-quality materials in the interior of the 911 GT2 reflect its sporting credentials: genuine leather and Alcantara. Offering exceptional grip and easy-care properties, Alcantara can be found wherever optimum hand contact is

required: on the steering wheel rim, gear lever, handbrake lever grip and door handles, as well as on the door panels, storage compartment lids and centre console.

The standard folding sport bucket seats and the optional adaptive sports seats are trimmed in black

leather, while the seat centres are covered with Alcantara. A GT2 logo is integrated in the rear bulkhead lining.

The front centre console has been totally redesigned and is now predominantly trimmed in classic black.



**Steering wheel.**

The three-spoke GT2 steering wheel can be manually adjusted for height and reach. The steering wheel is upholstered in Alcantara and the airbag module has a leather finish.

The multifunction steering wheel and the three-spoke sports steering wheel are also optionally available in smooth-finish leather.



Three-spoke sports steering wheel in smooth-finish leather



Sport bucket seat



Sport bucket seat, folded

**Sport bucket seats.\***

A car that is capable of such extreme lateral loads requires a seat with exceptional support. The standard sport bucket seat has manual fore/aft adjustment plus two additional features rarely encountered on comparable seat designs: a folding backrest and an integral thorax airbag in the side support.

The folding function enables easy access to the rear luggage area. The backrest pivots are positioned high in the side bolsters, providing optimum support for the torso, pelvis and legs. This is the first time ever that the lateral support of a bucket seat has been combined with a folding backrest.

The backrest shell has a glass-fibre reinforced plastic core and a carbon-fibre surface with visible weave pattern. This construction provides excellent rigidity while also reducing weight. The seat is compatible with a six-point racing harness.

The sport bucket seat features black leather with Alcantara centre; Dark Grey natural leather with

Alcantara centre is also available as an option. In conjunction with the Clubsport package (see page 64), it has a special flame-retardant fabric finish for added safety.

**Adaptive sports seats.**

Adaptive sports seats in leather with Alcantara centre are also available as a no-cost option. This alternative seat option combines excellent comfort with first-rate track performance. The comprehensive range of power adjustment controls includes fore/aft position, squab height, backrest angle and lumbar support. The side bolsters on the backrest and squab are

pneumatically adjustable for the perfect fit. This exceptional variability ensures generous comfort on long-distance journeys or precision support on the race-track. A memory function includes both exterior mirrors as well as all seat settings on the driver's side, with the exception of the side bolsters. The adaptive sports seats are also optionally available with seat heating.

**Storage compartments.**

The everyday usability of the 911 GT2 is as important as its performance, as evidenced by the storage compartments in the

centre console and door panels. Matching upholstered armrests above the storage compartments provide optimum driver comfort, particularly on long-distance trips. Twin cupholders for driver and front passenger are neatly concealed below the passenger airbag. Underneath is a lockable glove compartment with handy CD storage.

Two 12-Volt sockets (including the cigarette lighter) provide power for all your accessories.



Adaptive sports seat



Lockable glove compartment

\* Child restraint systems may not be used in conjunction with sport bucket seats.

**‘Welcome Home’ lighting.**

This standard lighting function provides comfort and safety at the push of a button. The low-beam headlights are automatically illuminated when the car is locked or unlocked using the key remote. The lights remain illuminated for a predefined period, lighting your way to or from the car. This delay is user-adjustable via Porsche Communication Management (PCM) on vehicles with the optional Sport Chrono Package Plus.

**ParkAssist.**

This optional parking aid is automatically enabled whenever you select reverse gear. Move too close to a stationary object and a warning signal is emitted. Continue to reverse and the tone increases in frequency. The distance is measured by ultrasonic sensors which are neatly concealed in the rear bumper.

**Cruise control.**

This convenient option has an effective range of 30– 240 km/h (19–149 mph). The system is operated using a switch in a separate control stalk on the steering column and can even be used in first gear.

**HomeLink® (garage door opener).**

This optional garage door opener is freely programmable and integrated within the cockpit. It offers remote control for up to three garage, gate, home lighting and/or alarm systems and is compatible



Luggage compartment

with almost all garage and exterior-door systems.

**Automatically dimming interior and exterior mirrors.**

An auto-dimming function is available as an option for the 911 GT2 for interior and exterior mirrors. The package also includes an integrated rain sensor for the front wiper system.

**Luggage compartment.**

The volume of the luggage compartment in the 911 GT2 is 105 litres. The entire compartment

is lined with high-quality, scratch-resistant materials. The bulkhead panelling conceals the amplifier of the optional BOSE® Surround Sound System and the DVD drive for the optional navigation module. The additional 205-litre rear load-space inside the car is easily accessible thanks to the folding sport bucket seats.

**Anti-theft protection.**

The 911 GT2 has an engine immobiliser with in-key transponder as well as a powerful alarm system featuring contact-sensitive exterior protection and radar-based interior surveillance as standard. The alarm system is activated and deactivated by a remote control function in the ignition key.

**Vehicle tracking system.**

The 911 GT2 can also be equipped with an optional factory-fitted preparation enabling future installation of a vehicle tracking



Chrono timer

system obtainable from Porsche Equipment. This system allows a stolen vehicle to be traced throughout most of Europe, and requires the installation of a special wiring loom and a high-capacity battery.

**Chrono Package Plus.**

The optional Chrono Package Plus combines a dash-mounted analogue/digital timer with a range of useful functions. Lap or journey times can be viewed, stored and analysed using the performance display in PCM. The information available includes time elapsed and distance travelled on the current lap, as well as the number of

laps completed and their respective times. You can also view the current fastest lap and remaining range till empty. Driving times can be recorded for any stretch of road, and benchmark times can be defined. Other useful features include a personal memory function, controlled via PCM, which stores personal preferences for a range of systems, including lights, wipers, door locks and air conditioning.



**The latest Porsche Communication Management (PCM).**

The 911 GT2 is fitted with the latest PCM as standard. As the central control unit for audio, navigation and communication, it is now even more powerful and versatile but

easier to operate, while retaining the basic logic of the menu system.

The main feature is the new 6.5-inch touchscreen for intuitive control. Naturally, you can also choose to operate the PCM via the button controls. The screen

display is very clear with a maximum of five list entries per page. A help function is displayed at the foot of the screen.

For radio listeners, there are up to 48 memory presets, an FM twin tuner with RDS which constantly

scans for the best signal for the selected station, and up to four radio antennae for optimum reception.

The integrated single CD/DVD drive, in combination with the optional BOSE® Surround Sound System, can now replay music from audio and video DVDs in 5.1 Digital Surround Format. As an option, a six-disc CD/DVD auto-changer can also be integrated in the PCM.

A TV tuner, available as an option, receives analogue and digital television broadcasts.

**Navigation module.**

The optional GPS navigation module now has a hard drive with map data for most European countries, allowing for faster route calculation with a choice of three alternative routes.

A touchscreen allows rapid destination input and gives information on traffic or special points of interest (POI) by simply touching the symbols on the map. Route diversions can be easily and quickly included in the current route guidance.

When viewing a map, it is possible to select either a new 3D perspective or the familiar 2D display. At motorway exits, graphical turn indications are displayed for better orientation. In split screen



mode, you can choose to display not only the current map overview, but also a list of icons that represent dynamic route guidance.

### Electronic logbook.

The optional electronic logbook allows automatic recording of mileage, distance covered, date and time, starting point and destination on each trip. Once you have downloaded the logbooks from the PCM via Bluetooth® or via the optional USB interface, the data can be analysed on your home PC using the software supplied. The software complies with all statutory requirements for automatic logbooks as specified by the German revenue authorities.

### TV tuner.

A TV tuner, available as an option, receives analogue and digital television broadcasts (DVB-T) to provide entertainment between journeys. For your safety, the TV picture cannot be displayed while the vehicle is in motion.

### Voice control system.

Almost all of the functions of the PCM can be controlled via the latest optional voice control system. The menu item is read aloud exactly as it is displayed on the

screen and the voice control system recognises commands or number sequences, irrespective of the speaker. It gives audible feedback and guides you through the functions. There is no need to 'train' the system. Phone book entries can be retrieved, a radio station selected or the navigation destination entered directly by speaking whole words, rather than dictating one letter at a time.

### Telephone module.

The optional GSM telephone module offers convenience and excellent reception. By inserting a SIM card directly into the PCM's integral SIM reader, calls can be made using either the hands-free facility or the optional cordless handset. For even more convenience, the Bluetooth® capability of a mobile phone can be used to make calls via the SIM Access Profile (SAP)\*. Once automatic

pairing is complete, the mobile phone's aerial is switched off to conserve battery charge and the phone operates via the car aerial. Depending on the mobile phone model, this gives access not only to the numbers on the SIM card but also to the phone's internal memory. Also, depending on the phone, it can be controlled using the PCM, the multifunction steering wheel or the voice control system, without it ever leaving your pocket.

### Mobile phone preparation.

As an option, the mobile phone preparation kit (with or without cradle) is available for Bluetooth® connection of mobile phones which only support the hands-free profile (HFP). For connection by HFP, the PCM acts merely as a hands-free system. Here, too, the mobile phone can remain tucked away. Only the basic phone functions can be operated using the PCM. The GSM connection is established via the aerial of the mobile phone.\*\*

### Universal audio interface.

With this optional feature, the storage compartment in the centre console will contain three connections: one for your iPod®, one for a USB stick/MP3 player and one as an AUX interface for any chosen compatible audio source. The iPod® or USB stick can be operated conveniently and safely via the PCM, the multifunction steering wheel or the voice control system. The USB connection can also be used to download data from the performance display of the Sport Chrono Package Plus and the electronic logbook.

### Sound Package Plus.

Fitted as standard is Sound Package Plus. A separate amplifier with a total rated output of 235 Watts, combined with nine speakers, ensures a perfect sound for the interior.



TV tuner

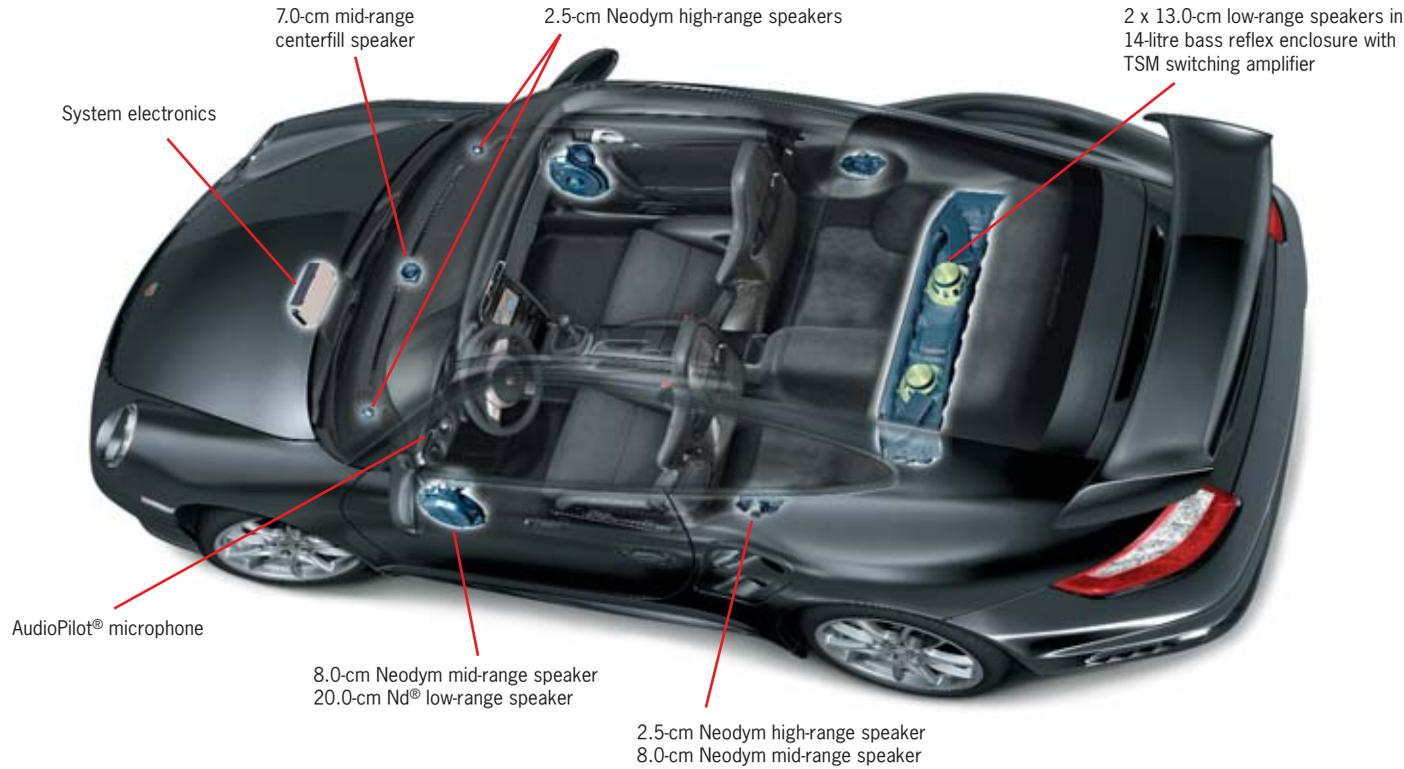

**One powerful sound experience meets another.**

**BOSE® Surround Sound System.**

True, the sound of the 911 GT2 itself is music to your ears. However, if you still want to listen to a concert, there's the optional BOSE® Surround Sound System.

It has been optimally designed for the specific interior acoustics of the 911 GT2. A total of 13 loudspeakers, including an active subwoofer and central speaker, and a 7-channel digital amplifier with a rated output of 385 Watts,

create an impressive sound experience.

When playing music from audio or video DVDs, the system now has the impressive sound spectrum of digital 5.1 recording. For music in

The digital 5.1 surround sound is balanced, lifelike and crystal clear. A 360° sound experience that is as close to a live performance as you could imagine.

Naturally, you can also play conventional CDs, either in stereo or in one of the surround modes generated by the BOSE® Centerpoint® technology. The new algorithm of Centerpoint® II extracts an even more precise and realistic sound from the stereo signal.

The SurroundStage® signal processing circuitry developed by BOSE® assigns each individual audio channel, whether sourced from a DVD or generated by Centerpoint®, to a selected combination of loudspeakers and thus delivers an optimally balanced surround sound experience to all seat positions.

To complement these features, the BOSE® Surround Sound System offers a comprehensive selection of equaliser presets for customised sound. The dynamic loudness function emphasises the bass notes as the volume

decreases to compensate for the diminishing sensitivity of human hearing at these frequencies. In addition, the AudioPilot® Noise Compensation Technology uses a microphone to continuously measure the ambient noise inside the vehicle and adapts music playback automatically to give a constant sound quality in all driving conditions.

The 911 GT2 and BOSE®: two complementary sound experiences of the highest quality.

the 5.1 format, the sound has already been recorded in a multi-channel format and is faithfully reproduced exactly as the original.

Five dedicated audio channels (front left, front right, centre, surround left, surround right) and a power channel for the bass frequencies deliver a sound that is as authentic as it is natural.



# Environment

Action speak louder than words.



**Powerful performance needn't cost the earth.**

**Environment.**

In an era of intensifying debate about CO<sub>2</sub> emissions, every automotive manufacturer is considering how to deal with the question of fuel consumption. Our answer has long been the same: maximum efficiency.

Porsche reduces the CO<sub>2</sub> emissions of its vehicles annually by an average of 1.7%. In relation to engine power, Porsche is already among those manufacturers achieving the lowest CO<sub>2</sub> emissions. This has been achieved through an efficient drive concept, optimised aero-

dynamics, low rolling resistance and lightweight construction.

This high degree of environmental responsibility is clearly demonstrated by our approach to environmental management at the Porsche development centre in Weissach.

Here, all technological developments are carried out with environmental protection in mind. The aim: pure performance – but not at the expense of the environment.

You can find more information about environmental matters in the separate brochure 'Porsche and the Environment', or on our website [www.porsche.com](http://www.porsche.com).

**Exhaust emission control.**

The 911 GT2 easily meets the stringent emissions standards for the EU4 regulations in Europe and LEV II regulations in the USA. This demonstrates that even high performance sports cars can achieve moderate emissions values in their respective categories. The 911 GT2 is not only one of the most powerful cars around, but also one of the cleanest. One pair of sensors is used to monitor the oxygen levels in each of the twin exhaust tracts. An additional pair of sensors\* – again, one on each tract – is located downstream from the cat-

alytic converters. This information is used by the engine management system to monitor the efficiency of the catalysis.

**Fuel.**

The current Porsche sports car model range is already compatible with fuels that have an ethanol content of up to 10%. A 'biofuel' made from naturally replenishing materials, ethanol has a positive impact on the carbon dioxide balance since the plants grown for its production also absorb carbon dioxide from the atmosphere.

**Fuel system.**

In the fuel supply system, we've minimised the evaporation of hydrocarbons. This is achieved through a combination of active carbon filter and special fuel-tank coating. All fuel lines are made from aluminium, while those carrying vapours are made from multi-layer plastic.

**Noise.**

The 911 GT2 complies with all noise regulations in the respective markets. Rather than resorting to engine encapsulation, we've eliminated noise at source. All that remains are the powerful acoustics you'd expect from a thoroughbred Porsche.

**Servicing.**

Longer service intervals are not only easier on resources, they also reduce ownership costs.

For service intervals of the 911 GT2, please refer to the price list.

\* Not featured in markets with leaded fuel.



## Personalisation

In the 911 GT2, your only weakness is the strength of your resolve.

**Colours.**

The 911 GT2 is available in a choice of four solid colours, six metallic colours and seven optional 'special' paint finishes. The interior is available in standard black leather trim or optional Dark Grey natural leather. Each combines elegantly with the various exterior options.

To see how the available colours would look on your car, visit [www.porsche.com](http://www.porsche.com) and use the online Porsche Car Configurator.

**Solid exterior colours.**



Black



Guards Red



Carrara White



Speed Yellow

**Metallic exterior colours.**



Basalt Black Metallic



Arctic Silver Metallic



Midnight Blue Metallic



Macadamia Metallic



Meteor Grey Metallic



Aqua Blue Metallic\*

**Special exterior colours.**



Atlas Grey Metallic



GT Silver Metallic



Ruby Red Metallic



Malachite Green Metallic



Porsche Racing Green Metallic



Nordic Gold Metallic



Cream White

**Standard interior colour.  
Leather/Alcantara.**



Black

**Natural leather/  
Alcantara interior.**

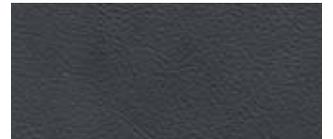

Natural Dark Grey\*\*

\* Available from 09/2008 at the earliest

\*\* Not in conjunction with Clubsport package available as a no-cost option.



Metallic paint, wheel centres with full-colour Porsche Crest

## Exterior.<sup>1)</sup>

Option		I no.	Page
• Metallic paint (no-cost option)	w	Code	88, 90
• Special colours	o	Code	89
• Deletion of model designation	w	498	
• ParkAssist (parking aid at rear)	o	635	74, 90
• Grey top tint on windscreen	o	567	
• Automatically dimming interior/exterior mirrors with integrated rain sensor	o	P12	74
• Wheel centres with full-colour Porsche Crest	o	446	90



ParkAssist

<sup>1)</sup> For exclusions and obligatory combinations of individual I numbers, please refer to the separate price list.

The vehicles pictured in the chapter on personalisation may include additional options not featured in this catalogue. For information on these options, please consult your Porsche Centre.

For information on the options featured in this catalogue, please refer to the price list.

o extra-cost option    w no-cost option



Clubsport package



Chrono Package Plus



Adaptive sports seat

## Interior.<sup>1)</sup>

Option		I no.	Page
• Clubsport package	w	003	64, 92
Bolt-in roll-over bar at rear, preparation for battery master switch. Supplied ready to install: six-point racing harness in red for driver's side, fire extinguisher (with mounting bracket)			
• Chrono Package Plus	o	640	75, 92
• HomeLink® (programmable garage door opener)	o	608	74
• Cruise control	o	454	74
• Preparation for vehicle tracking system	o	674	75
• Adaptive sports seats with memory	w	P01	73, 92
• Seat heating*	o	342	
• Fire extinguisher*	o	509	
• Floor mats with embroidered Porsche logo (set of two)	o	810	

<sup>1)</sup> For exclusions and obligatory combinations of individual I numbers, please refer to the separate price list.

\* Not available in conjunction with standard sport bucket seats.

The vehicles pictured in the chapter on personalisation may include additional options not featured in this catalogue.

For information on these options, please consult your Porsche Centre.

For information on the options featured in this catalogue, please refer to the price list.

o extra-cost option W no-cost option



Natural leather interior in Dark Grey

## Interior: leather.<sup>1)</sup>

Option		I no.	Page
• Leather interior package in natural leather (Dark Grey)	o	998	89, 94
• Three-spoke sports steering wheel in smooth-finish leather	w	460	71
• Three-spoke multifunction steering wheel in smooth-finish leather	w	431	71



Three-spoke multifunction steering wheel in carbon, carbon interior package plus various options from Porsche Exclusive

## Interior: carbon.<sup>1)</sup>

Option		I no.	Page
• Interior package in carbon	o	EZA	94
• Three-spoke multifunction steering wheel in carbon	o	453	94

<sup>1)</sup> For exclusions and obligatory combinations of individual I numbers, please refer to the separate price list.

The vehicles pictured in the chapter on personalisation may include additional options not featured in this catalogue. For information on these options, please consult your Porsche Centre.

For information on the options featured in this catalogue, please refer to the price list.

o extra-cost option W no-cost option



Electronic logbook



Cordless handset for telephone module

## Audio and communication.<sup>1)</sup>

Option	I no.	Page
• Navigation module	672	77
• Electronic logbook	641	78, 96
• Telephone module*	666	78
• Cordless handset for telephone module	669	96
• Mobile phone preparation**	619	79
• Mobile phone preparation with cradle**	618	79

<sup>1)</sup> For exclusions and obligatory combinations of individual I numbers, please refer to the separate price list.

\* For information on compatible mobile phones, please contact your Porsche Centre or visit [www.porsche.com](http://www.porsche.com).

\*\* Mobile phone preparation: The use of a mobile phone inside a vehicle may cause an increase in the interior electromagnetic field strength and, accordingly, in the electromagnetic radiation to which passengers are exposed. If a cradle is used to mount the mobile phone, the field strength inside the vehicle can be reduced by connecting to the exterior aerial (depending on how specific mobile phones connect to the cradle). For more information about the availability of a cradle for your mobile phone, please contact your Porsche Centre. Use of the telephone module for PCM prevents exposure to electromagnetic radiation as only the vehicle's exterior aerial is used.



Universal audio interface

## Audio and communication.

Option		I no.	Page
• Voice control	o	671	78
• TV tuner	o	676	78
• BOSE® Surround Sound System	o	680	80
• Six-disc CD-/DVD-autochanger*	o	693	76
• Universal audio interface (iPod®, USB, AUX)	o	870	79, 98
• External aerial	w	461	

\* May be incompatible with some copy-protected audio CDs/DVDs.



## Porsche Exclusive

### State of the art. And just as you want it.

Over and above the personalisation options listed in this catalogue, you also have the option of making your Porsche even more special with the Porsche Exclusive range. From the factory. As personal and

exclusive as you like, both visually and technically, inside and outside, in the best materials and with customary Porsche quality. The many design options offered by Porsche Exclusive are given in the separate Exclusive 911 catalogue. Your Porsche Centre will be pleased to give you further information on Porsche Exclusive.

Alternatively, you can call the Customer Centre in Zuffenhausen on +49 (0)711 911-25332. Please note that some Porsche Exclusive items may not be available for immediate delivery.

## Factory collection

**You won't be able to sleep the night before.**

**The night after, you won't want to.**

Where better to experience the first moments with your Porsche than at the place where it all began. With factory collection, you can enjoy the pleasure of Porsche ownership even before your car leaves the factory.

Almost 60 years ago, our first series production models were crafted by hand in a modest red-brick building here in Stuttgart-Zuffenhausen. From those humble beginnings, the factory has

evolved into one of the most advanced production facilities in the world. Today, all Porsche engines are constructed here along with all 911 models. You can also take delivery of any model in the Boxster or Cayman range.

Our factory collection programme offers a unique insight into the origins and making of your Porsche. Like your car, a visit to Zuffenhausen is an absorbing blend of past and future. To take advantage of this exclusive opportunity, please inform your Porsche Centre when placing your specification. A collection date can then be arranged when final information regarding the build of your car has been

confirmed. Your Porsche can be collected on any working day\* (Monday to Friday) at a time that suits your requirements.

The easiest way to travel from outside Germany is to fly to Stuttgart or Frankfurt and then continue by train, taxi or hire car (which we can return on your behalf).

Please note that there are a number of formalities that must be completed when you take delivery of your Porsche. For full details, please consult your Porsche Centre, who will also be happy to assist when it comes to planning your trip.

\* Please note that collection is not possible during the factory shutdown periods.

**Everything about a Porsche is more intense.**

**Especially the anticipation.**

Your visit to Zuffenhausen is also an opportunity to explore the origins of your Porsche. Our factory tour provides a fascinating insight into the various production processes. These range from engine assembly and the preparation of upholstery, to the 'marriage' of powertrain/chassis and body – one of the key moments in the construction of any car. The factory tour is one of our oldest traditions and is always conducted by a Porsche enthusiast with extensive knowledge of the marque.

Next, you can visit the Porsche Museum, where you'll find a remarkable range of Porsche models from every era of our history. A new Porsche Museum – scheduled for late 2008 – will offer even more exhibits, even more historical interest and even more of the Porsche experience.

For lunch, you can choose from a three-course menu in our exclusive guest restaurant.

If there's time, you can enjoy some additional refreshments in the customer lounge or browse in the Porsche Design Driver's Selection shop.

**The moment you've been waiting for.**

The highlight of your visit will undoubtedly be the moment when you take delivery of your Porsche. The keys will be presented by a member of the Factory Collection Team who will explain everything you need to know about the car.

When you step inside and start the engine, you'll finally experience what it means to own your own Porsche.

All that remains is the journey home – which is sure to live long in the memory.



Vehicle presentation area in Stuttgart-Zuffenhausen



Guest restaurant



Porsche Design Driver's Selection shop



### **Porsche Centres**

Your Porsche Centre can assist you with every aspect of purchasing and owning your Porsche. You will also find a wide range of products and services, including genuine Porsche parts and accessories.

### **Porsche Assistance**

Enjoy peace of mind with our exclusive breakdown and accident recovery service. Membership is free when you buy a new Porsche.

### **Porsche Financial Services**

Our innovative suite of financial services is specially tailored to the needs of Porsche owners. Products range from attractive finance and leasing options to vehicle insurance and the Porsche Card.

### **Porsche Exclusive**

Realise your vision of the perfect Porsche with our factory customisation programme. From styling enhancements to performance upgrades, all modifications are uniquely handcrafted for your Porsche.

### **Porsche Tequipment**

Personalise your Porsche at any time after purchase with the Tequipment range of approved accessories. Designed exclusively for your car, every product is fully guaranteed.

### **Porsche Design Driver's Selection**

With products ranging from fashion and accessories to tailored luggage, this unique collection combines quality and style with everyday practicality.

## Service

### **Porsche Used Car Programme**

Porsche Approved is the simple way to find the perfect pre-owned Porsche, anywhere in the world. Every car is rigorously tested and comes with a comprehensive vehicle warranty.

### **Porsche Classic**

Your specialist source for genuine Porsche parts and technical documentation as well as servicing, repair and restoration for all types of classic Porsche. Find out more at [www.porsche.com/classic](http://www.porsche.com/classic).

### **Christophorus**

Our bi-monthly magazine for Porsche owners has news, interviews and a wide variety of features from throughout the world of Porsche.

### **Porsche Clubs**

Since the first Porsche Club was founded in 1952, their number has grown to 607 with a total of 120,000 members worldwide. To find out more, call +49 (0)711 911-78307 or go to [www.porsche.com](http://www.porsche.com).

### **Porsche Driving Experience**

**1. Porsche Travel Club.** Exclusive driving holidays and incentive ideas combining luxury and adventure, worldwide. To find out more, call +49 (0)711 911-78155. E-mail: [travel.club@porsche.de](mailto:travel.club@porsche.de)

### **2. Porsche Sport Driving School.**

Develop your skill and explore your Porsche with the Porsche Sport Driving School. To learn about events at some of the world's most famous racing venues, call +49 (0)711 911-78683. E-mail: [sportdrivingschool@porsche.de](mailto:sportdrivingschool@porsche.de)



### **Porsche Online**

For all the latest news and information from Porsche, go to [www.porsche.com](http://www.porsche.com).



Ask your Porsche Centre for the latest brochures from Porsche Exclusive, Porsche Tequipment, Porsche Design Driver's Selection and the Porsche Driving Experience.



## Summary

With the 911 GT2, we've pushed our limits so you can discover yours. We've commanded your respect. Now have ours.

Respect required.  
The 911 GT2.

## Technical data

<b>Engine</b>	
<b>Cylinders</b>	6
<b>Displacement</b>	3,600 cm <sup>3</sup>
<b>Max. power (DIN)</b>	390 kW (530 hp)
<b>at rpm</b>	6,500
<b>Max. torque</b>	680 Nm
<b>at rpm</b>	2,200–4,500
<b>Compression ratio</b>	9.0 : 1
<b>Transmission</b>	
<b>Layout</b>	Rear-wheel drive
<b>Manual gearbox</b>	6-speed
<b>Chassis</b>	
<b>Front axle</b>	McPherson-strut suspension
<b>Rear axle</b>	LSA multi-link suspension
<b>Steering</b>	Variable steering ratio, power-assisted (hydraulic)
<b>Turning circle</b>	10.9 m
<b>Brakes</b>	Porsche Ceramic Composite Brake (PCCB): 6-piston monobloc aluminium fixed calipers at front, 4-piston monobloc aluminium fixed calipers at rear, discs internally vented and cross-drilled
<b>Vehicle stability system</b>	PSM
<b>Anti-lock braking system</b>	ABS 8.0
<b>Wheels</b>	Front: 8.5J x 19 ET 53 Rear: 12J x 19 ET 51
<b>Tyres</b>	Front: 235/35 ZR 19 (sport tyres) Rear: 325/30 ZR 19 (sport tyres)

<b>Weights</b>	
<b>Unladen weight (DIN)</b>	1,440 kg
<b>Unladen weight (EC)*</b>	1,515 kg
<b>Permissible gross weight</b>	1,750 kg
<b>Performance</b>	
<b>Top speed</b>	329 km/h (204 mph)
<b>0–100 km/h (0–62 mph)</b>	3.7 secs
<b>0–160 km/h (0–99 mph)</b>	7.4 secs
<b>0–200 km/h (0–124 mph)</b>	11.2 secs
<b>Flexibility 80–120 km/h (50–75 mph) in 5th gear</b>	4.1 secs
<b>Fuel consumption/emissions**</b>	
<b>In accordance with 80/1268/EC as valid at the time of going to print</b>	
<b>Urban in l/100 km (mpg)</b>	18.8 (15.0)
<b>Extra urban in l/100 km (mpg)</b>	8.9 (31.7)
<b>Combined in l/100 km (mpg)</b>	12.5 (22.6)
<b>CO<sub>2</sub> emissions in g/km</b>	298
<b>Dimensions/aerodynamics</b>	
<b>Length</b>	4,469 mm
<b>Width</b>	1,852 mm
<b>Height</b>	1,285 mm
<b>Wheelbase</b>	2,350 mm
<b>Luggage compartment volume</b>	105 litres
<b>Tank capacity (refill volume)</b>	90 litres
<b>Drag coefficient</b>	0.32

\* Weight is calculated in accordance with the relevant EC Directives and is valid for standard specification vehicles only. Optional equipment means greater weight. The figure given includes 68 kg for the driver and 7 kg for luggage.

\*\* The figures given refer to vehicles with standard specification in Germany. Data determined in the NEDC (New European Driving Cycle) in accordance with the EU5 (80/1268/EEC) measurement method in the version valid at time of going to print. The figures do not relate to an individual vehicle, nor do they constitute part of the offer. They are intended solely as a means of comparing different types of vehicle. Further information on the individual vehicles can be obtained from your Porsche Centre.

# Index

<b>A</b>		<b>D</b>		<b>G</b>		<b>M</b>		<b>R</b>		<b>T</b>	
ABS	51	Design	16	Gearbox, manual	38	Mobile phone preparation	79	Ram air principle	17	Technical data	106
Air conditioning, automatic	69	Drive	18	GSM telephone module	78			Rear axle	45	Telephone module	78
Airbags	62	Dual-mass flywheel	39			<b>N</b>		Rear wing	17	Traction control (TC)	14, 50
Alarm system	75			<b>H</b>		Navigation module	77	Recycling	84	Transmission	38
Anti-theft protection	75	<b>E</b>		HomeLink®	74	Noise	85	Roll cage	64, 92	Turbocharger	28
Audio system	76	Electronic logbook	78			<b>O</b>				TV tuner	78
		Engine	20	<b>I</b>		Oil supply	25	<b>S</b>		Tyre Pressure	
<b>B</b>		Engine cooling	26	Ignition system	35	On-board computer	69	Safety	54	Monitoring (TPM)	47
Bi-Xenon lighting system	56	Engine management system	36	Instruments	68	Oxygen-sensor control	34, 85	Safety, active	56		
Bodyshell structure	60	Environment	82	Interior	68, 93			Safety, passive	60	<b>U</b>	
BOSE® Surround		Exhaust emission control	85	Interior materials	70, 95	<b>P</b>		Seats	72	Universal audio interface	79
Sound System	80	Exhaust system	34			ParkAssist	74, 90	Seats, adaptive sports	73, 92		
Braking system	58	Expansion intake manifold	32	<b>K</b>		Personalisation	86	Seats, sport bucket	15, 72	<b>V</b>	
		Exterior	91	Knock control, cylinder-specific	36	Porsche Active Suspension Management (PASM)	48	Service	102	Variable Turbine Geometry (VTG)	28
<b>C</b>						Porsche Ceramic Composite	58	Servicing	85	VarioCam Plus	26
Catalytic converters	34, 85	<b>F</b>		<b>L</b>		Brake (PCCB)	58	Six-cylinder twin-turbo boxer engine	20, 24	Vehicle tracking system	75
Charge-air cooling	16	Factory collection	100	Launch Assistant	38	Porsche Communication Management (PCM)	76	Sound Package Plus	79	Voice control system	78
Chassis	42	Fire extinguisher	64, 93	Leather	89, 95	Porsche Side Impact		Sport tyres	46		
Chrono Package Plus	75, 92	Front axle	44	Lightweight design	24	Protection (POSIP)	62	Stability control (SC)	14, 50	<b>W</b>	
Clubsport package	64, 92	Fuel supply	35	Loudspeakers	79, 80	Porsche Stability Management (PSM)	50	Steering	52	'Welcome Home' lighting	74
CO <sub>2</sub>	84	Fuel system	35, 85	Lubrication, dry-sump	25			Steering wheel	71	Wheels	46
Colours	88			Luggage compartment	74			Storage compartments	73		
Comfort	66										
Communication	76, 96										
Cruise control	74										

The models featured in this publication are approved for road use in Germany. Some items of equipment are available as extra-cost options only. The availability of models and options may vary from market to market due to local restrictions and regulations. For information on standard and optional equipment, please consult your Porsche Centre. All information regarding construction, features, design, performance, dimensions, weight, fuel consumption and running costs is correct at the time of going to print. Porsche reserves the right to alter specifications and other product information without prior notice. Colours may differ from those illustrated. Errors and omissions excepted.

© Dr. Ing. h.c. F. Porsche AG, 2008  
All text, images and other information in this publication are copyright  
Dr. Ing. h.c. F. Porsche AG.

No part of this publication may be reproduced or transmitted, in any form or by any means, without prior permission in writing from Dr. Ing. h.c. F. Porsche AG.

Porsche, the Porsche Crest, 911, Carrera, Tequipment, PCCB, PCM and PSM are registered trademarks of Dr. Ing. h.c. F. Porsche AG.

Dr. Ing. h.c. F. Porsche AG supports the use of paper from sustainable forestry. This catalogue is printed on paper made from 100% PEFC-certified pulp (Program for the Endorsement of Forest Certification).

Dr. Ing. h.c. F. Porsche AG  
Porscheplatz 1  
70435 Stuttgart  
Germany  
[www.porsche.com](http://www.porsche.com)

Edition: 03/08  
Printed in Germany  
WVK 235 320 09 GB/WW

