



PORSCHE



**The new 911 GT3 RS and 911 GT3**  
Extreme truth





<b>The 911 GT3</b>	<b>6</b>
<b>The new 911 GT3 RS</b>	<b>18</b>
<b>Drive</b>	<b>30</b>
<b>Chassis</b>	<b>46</b>
<b>Safety</b>	<b>58</b>
<b>Comfort</b>	<b>70</b>
<b>Motorsport</b>	<b>80</b>
<b>Environment</b>	<b>90</b>
<b>Personalisation</b>	<b>94</b>
<b>Service</b>	<b>108</b>
<b>Summary</b>	<b>110</b>
<b>Technical data</b>	<b>112</b>
<b>Index</b>	<b>114</b>

## The 911 GT3

For many motorsport is enjoyable.  
For us it is a core value.







higher torque, resulting in 320 kW (435 hp) at 7,600 rpm. The maximum engine speed is 8,500 rpm and maximum torque is 430 Nm at 6,250 rpm. Impressive values, especially if you look at the performance figures it can achieve.

A smooth six-speed manual gearbox effectively transmits this power onto the road. The gear-lever throw is short and the handling precise.

With regard to propulsion, two values sum up the potential power of the 911 GT3. Firstly, acceleration: 4.1 seconds from 0 to 100 km/h (62 mph). Secondly, maximum speed: acceleration doesn't stop until the car reaches 312 km/h (194 mph).

Improved driving dynamics and stability are achieved with the optional new dynamic engine mounts (page 48). This system

reduces vibration and the movement of inert masses in the power unit by automatically modifying the stiffness and damping of the engine mounts.

## You can develop a sportscar from experience. Or from the heart.

### The 911 GT3.

You might be able to build a sportscar with experience alone. But never a Porsche – and especially not a 911 GT3. That takes much more: engineers who are dedicated to the development of race cars right from the start. Whose passion is for motorsport, above all else. Engineers who firmly oppose any

form of compromise. Developed from the heart. The 911 GT3.

At the heart of the 911 GT3 is the engine. A development from motorsport, of course. An engine with more power than its predecessor, but with a similar level of fuel consumption.

The key data: a flat-six Boxer engine located right at the back for a low centre of gravity and increased traction on the drive axle. The cubic capacity is 3.8 litres. The engine has advanced VarioCam, a system for adjusting the inlet camshafts, and also the outlet camshafts. This gives even more power and



Porsche Active Suspension Management (PASM, page 56) ensures a responsive drive and superior handling.

Everything that's crucial for use on the racetrack can be adjusted on the chassis, including the settings for height, camber, toe angle and the anti-roll bars on the front and rear axles.

The 911 GT3 has Porsche Stability Management (PSM, page 54) with two control systems: Stability

Control (SC) to provide stabilisation within the limits of driving dynamics and Traction Control (TC) to regulate the longitudinal dynamics and improve acceleration on various road surfaces. Both systems can be disabled completely in two stages – for an active driving experience on the racetrack.

One feature that has come directly from motorsport is the central locking device for the 19-inch GT3 wheels (page 52). The road-approved sport tyres are designed

to enable higher cornering speeds, as well as precision handling on the road or racetrack. Tyre Pressure Monitoring (TPM) is included as standard.

Everything on the 911 GT3 is designed to save weight. The doors and front lid are made from aluminium and the engine cover is made from a lightweight synthetic material. The result: a weight-to-power ratio of just 3.2 kg per hp.



If that were not enough, especially for use on the racetrack, instead of the conventional battery, Porsche is offering an optional lithium-ion battery (page 75). The main advantage is a weight saving of approx. 10 kg.

Even everyday use has been considered, with a new optional ride-height lift system for the front axle (page 51). At low speeds, the front of the vehicle can be raised by 30 mm if there is a risk of it grounding.

Our approach to safety is as uncompromising as usual, in terms of both active and passive safety features. A heavy-duty but lightweight braking system offers excellent performance, even in extreme conditions. To reduce weight, the monobloc calipers in the compound brake disks are made from aluminium. Porsche Ceramic Composite Brake (PCCB, page 64) is also available as an option.

For additional protection on the racetrack, a Clubsport package (page 68) is available as a no-cost option.

The latest in communication technology is also included with the standard CDR-30 audio system or the optional Porsche Communication Management (PCM, page 77).

The 911 GT3. Developed from the heart so that you do not have to make compromises.

### Along ideal lines.

### The aerodynamics and design of the 911 GT3.

In motorsport there are clear rules. One of these is to push the boundaries of performance. An attribute that is clearly reflected in the exterior of the 911 GT3 with a design that follows function in every respect.

The front air vents, ahead of the front lid, channel cooling air to the radiator and, in combination

with the front lip spoiler, provide even more front-end downforce. As is typical in motorsport, all of the cooling air inlets are protected by air inlet grilles with a dark grey powder-coated finish.

The lights enhance the powerful appearance of the 911 GT3, with Bi-Xenon headlights fitted as standard. Indicators and LED

daytime running lights are harmoniously integrated into the separate front light units over the outer air intakes.







At the rear, distinctive LED lights are drawn right into the wing and taper outwards. Unmistakable – just like the fixed bi-plane wing. This provides aerodynamic downforce and greater driving stability, even at the highest speeds. It is made from light-weight synthetic material and the angle of incidence on the upper wing profile can be adjusted for use on the racetrack. Embossed on the side plates of the rear wing: '3.8'. A

reference to the engine size and a clear indication of its power.

As the car's speed increases, two ram-air collector intakes on the engine lid help to force additional air into the intake manifold and engine compartment. Another distinctive feature of the 911 GT3 is the central, black dual-tube tailpipe of the sports exhaust system.

The combined effect of all of these aerodynamic refinements is a low drag coefficient of just 0.32. Also, greater downforce, better aerodynamic balance, excellent road-holding characteristics, better directional stability and improved driving safety. Our core motorsport values can be both felt and seen in the new 911 GT3.

## The new 911 GT3 RS

Life is not a spectator sport.







The transmission? Manual. Six gears. Short shift precision gear changes. The ratio of gears 1 to 5 is about 13% shorter than in the 911 GT3. For better acceleration and more torque. Instead of a dual-mass flywheel, the new 911 GT3 RS uses a single-mass flywheel which is lighter and allows the engine to rev more freely.

Porsche Active Suspension Management (PASM, page 56) is set for even higher performance than in the 911 GT3. Of course, in the new 911 GT3 RS as well, height, camber and toe-angle, and the front and rear axle stabilisers, can be adjusted individually for use on the racetrack. In addition, the wishbone on the rear axle of the

new 911 GT3 RS is split so that camber can be set even more precisely to meet the demands of motorsport.

**No illusions. No compromises.  
Nothing but the truth.**

**The new 911 GT3 RS.**

A new RS? Didn't we reach the pinnacle with the last model? But we couldn't stop thinking about it. It kindled our ambition. We defined a lap time that seemed impossible even for a 911 GT3 RS. Now we know better.

Based on the 911 GT3, it had the best starting point. The task set for our engineers was clearly

defined: more power, higher performance and faster lap times.

To increase engine power, the air intake system was reviewed and improved using a new air filter. The result is a vehicle for maximum performance powered by a six-cylinder Boxer engine with 3.8-litre displacement and enhanced VarioCam timing (page 36).

The performance figures: 331 kW (450 hp) at 7,900 rpm. Maximum torque is 430 Nm at 6,750 rpm. Maximum revs are reached at 8,500 rpm.

Values that speak for themselves. Producing power that demands respect. From stationary, the new 911 GT3 RS can accelerate to 100 km/h (62 mph) in just 4.0 seconds. The maximum speed is: 310 km/h (193 mph).



The new dynamic engine mounts (page 48) are fitted as standard in the 911 GT3 RS. This system reduces the vibration and movement of the power unit by changing the damping and stiffness of the engine mounts. For a noticeable increase in driving dynamics.

The excellent driving stability is down to Porsche Stability Management (PSM, page 54), which includes two control systems,

Stability Control (SC) and Traction Control (TC). However, if you want to perfect your driving skills on the racetrack, PSM can be disabled completely in two stages.

The 19-inch GT3 wheels (page 52) with central locking device and 'RS' logo are fitted with road-legal sports tyres. Compared to the 911 GT3, the tyres are wider on the front and back and have a smaller offset on the front and rear

axle. This increases the toe angle by 12 mm and 30 mm, resulting in even greater stability. And so even higher performance levels.

In addition to power and precision, an essential consideration when designing the 911 GT3 RS was, of course, lightweight construction. A weight-to-power ratio of only 3.0 kg/hp has been achieved thanks to the use of materials taken directly from motorsport,



including titanium, aluminium and carbon. The new 911 GT3 RS also has lightweight door panels and a rear window made from a synthetic material. For use on the racetrack, for the first time Porsche is offering an optional lithium-ion battery (page 75), thus saving another 10 kg.

Developing a driving machine like the new 911 GT3 RS also means taking responsibility. Firstly, for the driver's safety. As in the 911 GT3, the braking system has been improved – the new composite brake discs with aluminium monobloc calipers are highly efficient. Porsche Ceramic Composite Brake (PCCB, page 64) is available as an option. The Clubsport package (page 68) and the sports bucket seats with the 'RS 3.8' logo on the headrests are standard.

More power. Greater driving dynamics. Less weight. Not an easy task. And all just for a few tenths of a second less. Because to you – and to us – they mean everything.

### The design speaks a clear language. The language of functionality.

### The aerodynamics and design of the new 911 GT3 RS.

The requirements were unambiguous: no gimmicks. It is not the eye that will make the decision, but the pointer on the timer. Although some may disagree.

The difference from the 911 GT3 can be seen at first glance. The body of the new 911 GT3 RS is wider – 44 mm at the rear axle and also, for the first time, 26 mm at the front axle. This

enables a wider toe-angle and the user of wider tyres for greater stability and improved cornering. Like the 911 GT3, the 911 GT3 RS has new air inlet grilles – effective protection for the cooling air inlets.

A striking visual feature is the fixed rear wing, bringing technology straight from the racetrack

for excellent driving stability and downforce. The mounts are made from forged aluminium and the carbon rear wing can be adjusted for use on the racetrack.







The engine lid with a 'GT3 RS' logo and the rear window are made from a lightweight synthetic material, as is the new rear middle section. A typical feature is the additional large air inlet on the engine cover (ram-air collector) for increased air intake and even better cooling.

The dual-tube tailpipe is integrated into the centre of the body. The silencer and tailpipes are made from lightweight titanium. Their

diameter is 5 mm larger than those on the 911 GT3. You can see, and hear the difference.

Another, particularly noticeable difference compared to the 911 GT3 is the paintwork. The air inlet frame on the front, the wheels, the wing mirrors, the logo above the wings and on the engine lid as well as the side plates on the rear wing are painted in a contrasting colour – as is the decorative side logo.

A further reflection of the car's sporting credentials is the new Aluminium Look fuel filler cap.

In short, it gets noticed. Certainly because of its design, but especially because of its effective aerodynamics. The result is greater downforce front and rear, ensuring excellent road-holding, stability and handling.

## Drive

Many ignore the figures that come after the decimal point. We measure ourselves against them.





## You can't get much closer to the truth.

### The engines.

Powering the 911 GT3 models is a water-cooled six-cylinder Boxer engine with four-valve technology and enhanced VarioCam variable valve timing (page 36). The vehicle's high-performance concept produces an impressive maximum engine speed of 8,500 rpm.

In the 911 GT3, the engine generates 320 kW (435 hp) from a total

displacement of 3,797 cm<sup>3</sup>, corresponding to an output of 115 hp per litre. The maximum torque is 430 Nm at 6,250 rpm. The 911 GT3 accelerates to 100 km/h (62 mph) in 4.1 seconds with a maximum speed of 312 km/h (194 mph).

The 3.8 litre engine in the new 911 GT3 RS delivers even more

power: 331 kW (450 hp). The output is 118 hp per litre. This increase is due to the two new double-flow air filter housings and the new variable intake manifold with larger intake tubes than those used on the 911 GT3. The greater throughput of air increases engine power. In terms of performance data, the maximum torque of 430 Nm is reached at 6,750 rpm.

3.8-litre Boxer engine

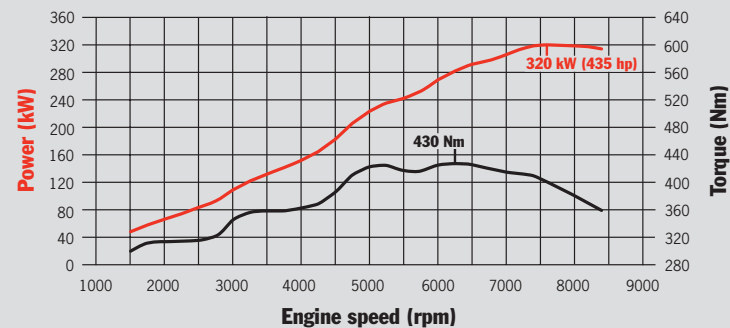

911 GT3: 430 Nm at 6,250 rpm, 320 kW (435 hp) at 7,600 rpm

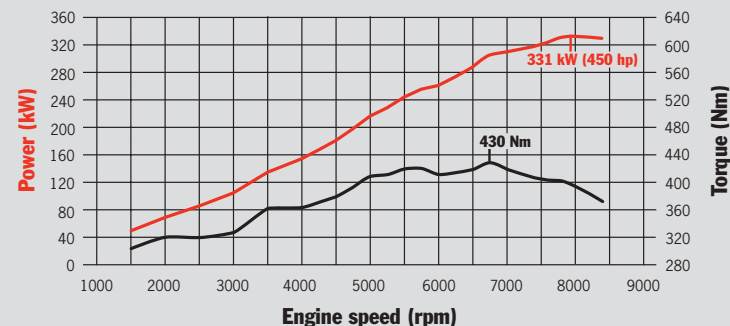

911 GT3 RS: 430 Nm at 6,750 rpm, 331 kW (450 hp) at 7,900 rpm

Pressing the SPORT button, fitted in both models, activates up to 35 Nm in the middle engine speed range below the maximum torque.

The new 911 GT3 RS passes the 100 km/h (62 mph) mark in 4.0 seconds. Short ratios increase the ventilation and acceleration potential in all six gears. Consistent aerodynamics, designed for downforce, allow high cornering speeds and excellent driving stability and performance. However, the maximum speed is still an impressive 310 km/h (193 mph).

The 911 GT3's weight to power ratio is 3.2 kg per hp. In the new 911 GT3 RS it is 3.0 kg per hp.

In conclusion: increased power and performance – but with fuel consumption comparable to that of their predecessors. In addition, both engines meet the stringent requirements of the Euro 5 emissions standard.

A consistent supply of oil to the engines even at times of high lateral acceleration, is ensured by a dry sump lubrication system (page 36) with an external engine oil reservoir. The oil is cooled by an oil-water heat exchanger. Both of these systems have proven themselves on the racetrack.

An extremely lightweight titanium connecting rod and lighter pistons reduce oscillating masses, thus ensuring dynamic engine speed development. The inlet and exhaust valves are actuated by especially lightweight tappets and hydraulic valve clearance adjustment.

This enables a maximum engine speed of 8,500 rpm which, together with the short sporty gear

ratios, provides plenty of performance.

Added to this is a variable intake manifold with two resonance valves (page 38) which work together with the sports exhaust system to ensure efficient cylinder charging and high throughput rates. The large volume of the exhaust system supplements the low-resistance intake manifold to improve cylinder

charging and increase performance.

In brief, it is all about performance – including driver performance. We have simply provided the right conditions for it.

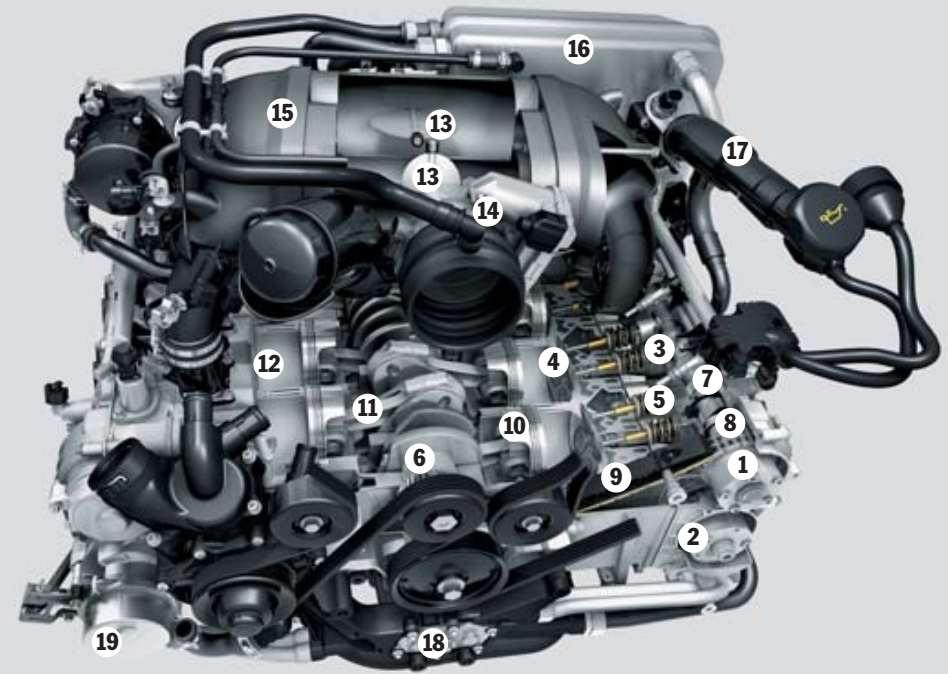

3.8-litre Boxer engine 911 GT3



- |   |   |  |
|---|---|--|
| <b>1. VarioCam for inlet valves</b>                         | <b>10. Forged aluminium piston</b>                              | <b>18. Oil scavenge pumps for cylinder heads</b> |
| <b>2. VarioCam for outlet valves</b>                        | <b>11. Titanium connecting rod</b>                              | <b>19. Vacuum pump</b>                           |
| <b>3. Tappets with hydraulic valve clearance adjustment</b> | <b>12. Nikasil-coated cylinder bore</b>                         |  |
| <b>4. Inlet valves</b>                                      | <b>13. Resonance valve</b>                                      |  |
| <b>5. Valve springs</b>                                     | <b>14. Throttle valve (electronically actuated)</b>             |  |
| <b>6. Crankshaft</b>  | <b>15. Variable intake manifold</b>                             |  |
| <b>7. Intake camshaft</b>                                   | <b>16. Separate engine oil reservoir (dry-sump lubrication)</b> |  |
| <b>8. Camshaft drive chain</b>                              | <b>17. Oil filler pipe</b>                                      |  |
| <b>9. Tensioner rail</b>                                    |   |  |



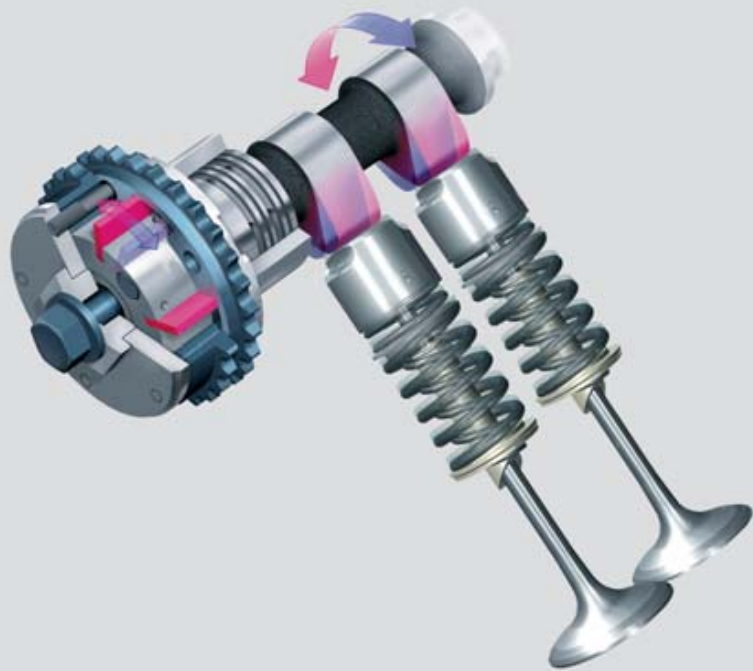

VarioCam

**VarioCam.**

Both engines in the 911 GT3 models are equipped with enhanced VarioCam. This system not only adjusts the camshafts on the inlet side according to engine speed and load, it also controls the exhaust camshaft – for even more power and torque. The continuous valve timing adjustment is performed by a rotary-type adjuster on each camshaft. VarioCam is an engine control concept that

distinguishes between different load scenarios and adapts to the corresponding power requirement.

The adjustment is performed seamlessly by the Motronic ME7.8.2 electronic engine management system. This enables smoother running characteristics, better fuel economy, lower exhaust emissions and, most importantly of all, added power and torque across the entire engine speed range.

**Dry-sump lubrication.**

A consistent oil supply is fundamental to track and competition driving. This is ensured by the dry-sump lubrication system, even during high lateral and longitudinal acceleration.

Once it has passed through the engine, two scavenge pumps in each cylinder head and another two in the crankcase take the engine oil quickly back to an external reservoir.

The oil pumps are designed so that there is negative pressure in the crankcase. This reduces resistance to the movement of the pistons to improve power output and efficiency. Another pump in the crankcase supplies the lubricating points in the engine from the external reservoir.

For the engine this means consistent lubrication of the crankshaft assembly and the two cylinder banks, even under very high lateral and longitudinal loads which are possible with sport tyres.

The 911 GT3 and the new 911 GT3 RS are factory-filled with Mobil 1 high-performance fully synthetic oil. Its exceptional lubricating properties ensure reliable starting even in the coldest conditions and, importantly, contribute to the long-term durability of the engine



### Intake manifold.

The 911 GT3 models are equipped with a variable intake manifold with two resonance valves – and larger intake pipes in the new 911 GT3 RS. The intake manifold works in conjunction with the sports exhaust system, featuring two central tailpipes, to achieve optimum cylinder charging and throughput rates.

In addition to a conventional distributor pipe, the 911 GT3 and the new 911 GT3 RS have two resonance pipes with resonance valves. At low engine speeds both resonance valves are closed. At medium rpm, the first, smaller valve opens. At high rpm, both valves open. The system uses the vibrations in the air caused by the movement of the engine valves to force air into the cylinders.

The result: higher levels of power and torque over a wider engine speed range.

### Sports exhaust system.

The lightweight sports exhaust system in the 911 GT3 models consists of two front silencers, two catalytic converters and one rear silencer. The exhaust on the

911 GT3 intake manifold



911 GT3 sports exhaust system



911 GT3 is painted black, whereas on the 911 GT3 RS it is made from titanium. The system's large volume reduces exhaust back pressure to increase power.

Each of the two banks of cylinders has its own separate exhaust tract. The position and design of the catalytic converters enable rapid warm-up to ensure effective emissions control.

Thanks to its advanced exhaust technology, both 911 GT3 models meet the strict requirements of international emissions standards such as Euro 5 in Europe and LEV II in the USA.

An oxygen sensor system monitors the composition of the exhaust gas individually for each bank of cylinders. An additional oxygen sensor in each exhaust section monitors the conversion of pollutants in each catalytic converter.\*

What that means for you is more power – but not at the expense of the environment.

\*Not in markets with leaded fuel.

### Rule no. 1 on the racetrack: Don't lose time unnecessarily.

#### Transmission.

We have certainly kept to that rule, as the six-speed manual gearbox in the 911 GT3 models has been designed especially for the high demands of motorsport. This lightweight gearbox is highly efficient and the gear-lever throw is short and precise, enabling fast

and accurate gearshifts. In conjunction with the friction-optimised cable pull shift, the gearbox provides an extremely high level of precision and capacity. Unlike the 911 GT3, which has a dual-mass flywheel, the new 911 GT3 RS uses a single-mass flywheel. It is

lighter and therefore increases engine dynamics. The engine turns even more easily in its upper speed ranges – with a somewhat higher noise level.





911 GT3 RS

- |                             |   |   |  |                                |                           |
|-----------------------------|---|---|--|--------------------------------|---------------------------|
| 1. Radiator module          | 5. Separate engine oil reservoir (dry-sump lubrication) | 7. Throttle valve (electronically actuated) | 9. Generator                               | 12. Multi-link rear suspension | 16. Composite brake discs |
| 2. Central radiator         | 6. Variable intake manifold                             | 8. Coolant expansion tank                   | 10. Front silencer                         | 13. PASM damper                | 17. Engine mount          |
| 3. Tandem brake booster     |   |   | 11. Main silencer on sports exhaust system | 14. Oil filler pipe            |                           |
| 4. Six-speed manual gearbox |   |   |  | 15. Air filter                 |                           |

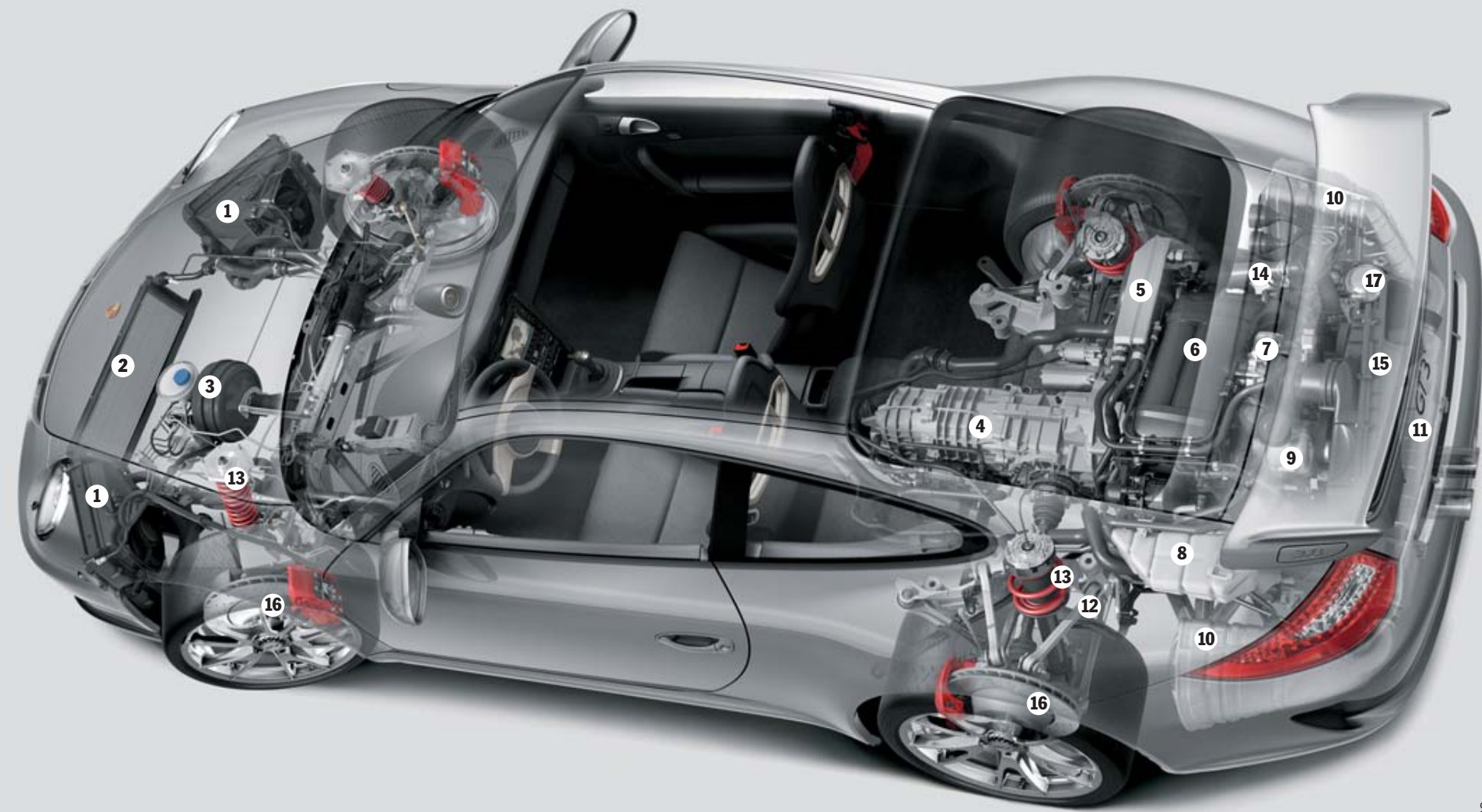

911 GT3

- |                             |   |   |  |                                |                           |
|-----------------------------|---|---|--|--------------------------------|---------------------------|
| 1. Radiator module          | 5. Separate engine oil reservoir (dry-sump lubrication) | 7. Throttle valve (electronically actuated) | 9. Generator                               | 12. Multi-link rear suspension | 16. Composite brake discs |
| 2. Central radiator         | 6. Variable intake manifold                             | 8. Coolant expansion tank                   | 10. Front silencer                         | 13. PASM damper                | 17. Engine mount          |
| 3. Tandem brake booster     |   |   | 11. Main silencer on sports exhaust system | 14. Oil filler pipe            |                           |
| 4. Six-speed manual gearbox |   |   |  | 15. Air filter                 |                           |



The gear ratios are perfectly matched to the two 3.8-litre engines. In the new 911 GT3 RS the ratio of gears 1 to 5 is about 13% shorter than in the 911 GT3, for an even more dynamic power development. Maximum speed is reached in 6th gear.

Robust steel heat-resistant baulk rings on gears three to five enable a precise gearshift action even under extreme loads. Cooling is provided by an additional oil-to-water heat exchanger and spray lubrication. Both of these features are essential for durability in endurance racing conditions.

The lock factors of the locking rear differentials that are standard for both models – 28% when cornering under power and 40% when cornering on the overrun – are optimally matched to the engines' power and torque characteristics. For better acceleration and handling when exiting a corner.

## Chassis

Exceptional dynamics. Excellent stability. Direct connection with the road. All other adjustments are up to you.

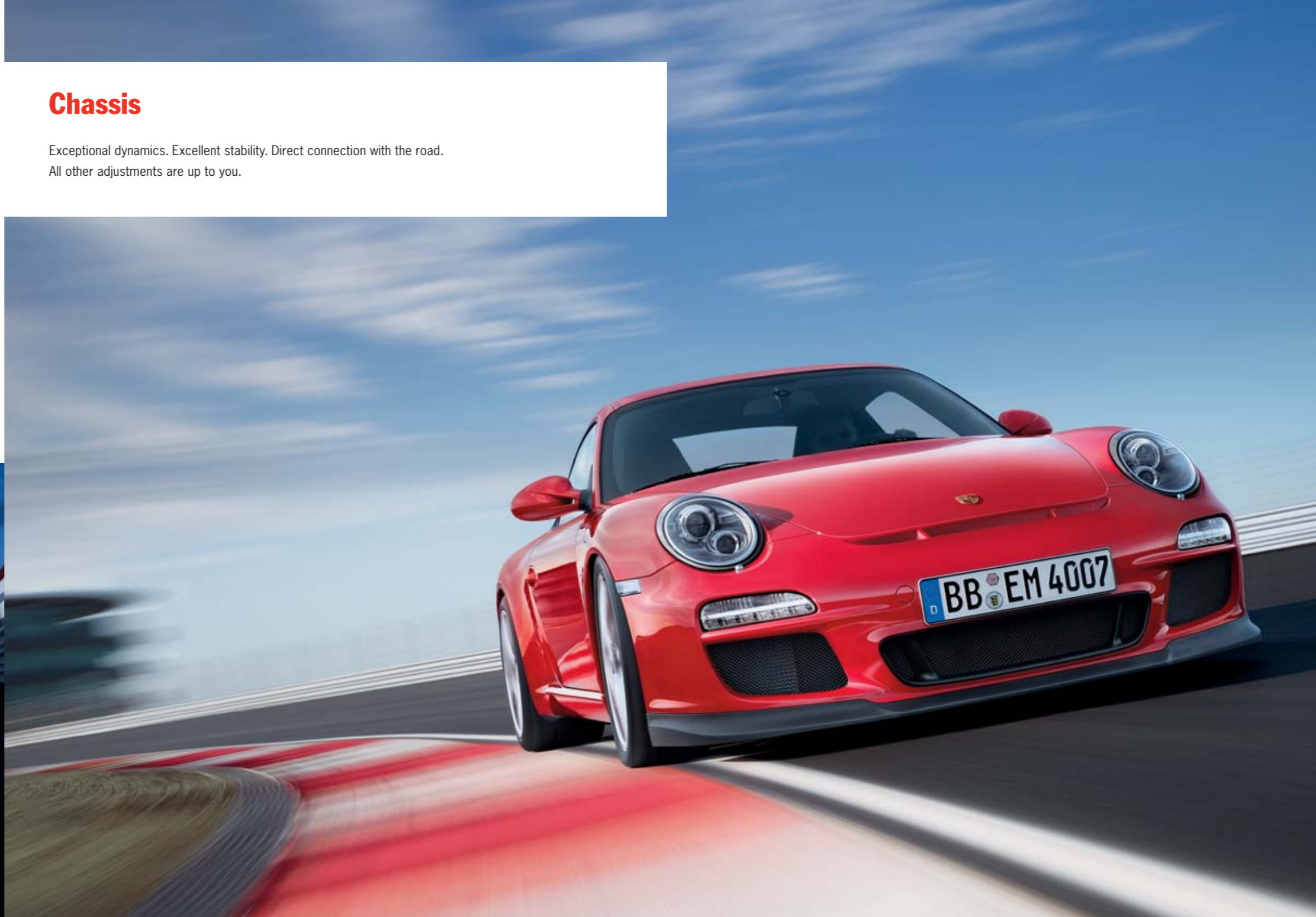



**We've always considered the laws of physics a challenge. Thankfully our engineers haven't.**

**The new dynamic engine mount system.**

Adding to driving dynamics: the dynamic engine mount system is available as an option in the 911 GT3 and is standard in the 911 GT3 RS. This electronically controlled system minimises noticeable oscillations and vibrations in the whole drive system, particularly the engine.

The engines in the 911 GT3 models are bolted to the body using two mounts. According to Newton's law of inertia, a body will continue to move in a uniform straight line unless it is made to change its direction by a force acting upon it. Put more simply: when you are driving into a bend, the vehicle will follow your steering

but, at first, the mass of the engine won't. This means that the rear of the vehicle is pushed outwards after a time lag because of the inert forces from the engine's mass acting on it.

The dynamic engine mount system minimises this effect. The steering angle, longitudinal and lateral

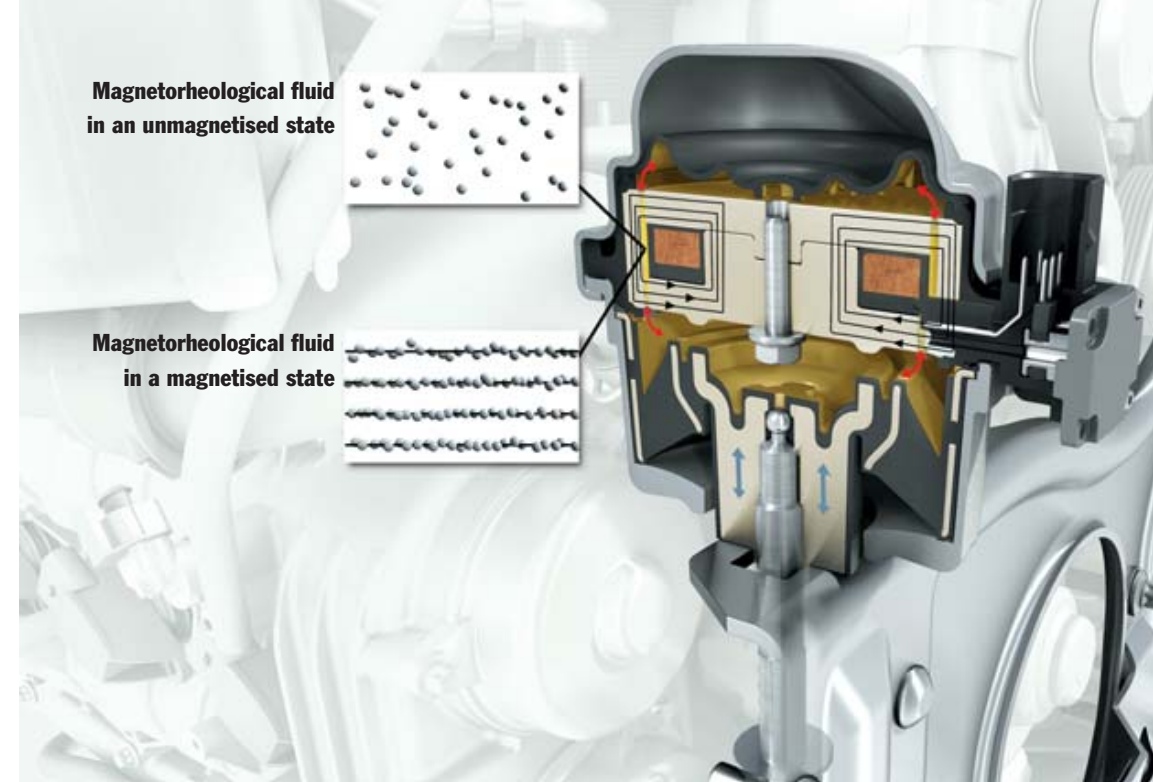

Dynamic engine mount system



acceleration values are constantly recorded by sensors and the stiffness of the two engine mounts is changed automatically according to the driving style. This is achieved using a magnetisable (magnetorheological) fluid and an electrically generated magnetic field. The magnetisable particles align with each other and the fluid's viscosity changes. This alters the stiffness and absorption of the engine mounts: softer for greater

comfort and less vibration when driving normally, harder for a more direct driving feel when driving more sportily. Similar characteristics to those of the 911 GT3 race cars where the engine is bolted directly to the body.

The dynamic engine mount system also reduces the vertical oscillations of the engine when accelerating under full load. The result: greater and more uniform

force on the rear axle, increased traction and better acceleration.

In everyday driving and on the racetrack, this means more stability in all driving situations.

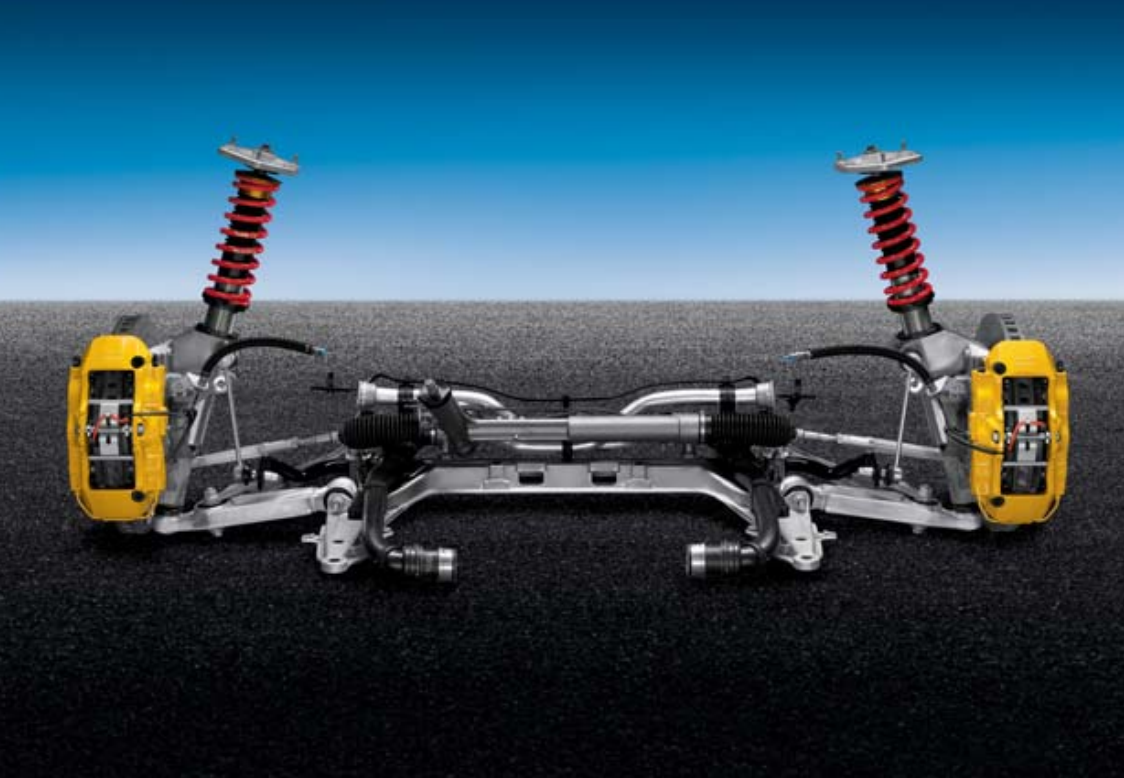

911 GT3 rear axle with Porsche Ceramic Composite Brake (PCCB)

## The connection between the heart and the mind. Transferred to the car and the road.

### Chassis.

The chassis of the 911 GT3 and the new 911 GT3 RS is designed to meet the high demands of motorsport. The cars are therefore approximately 30 mm lower than the 911 Carrera. Their light-weight construction offers major weight savings, not least in terms of unsprung mass, for exceptional agility, a high level of safety and inherent stability, especially when cornering.

The front axle has McPherson-type struts with the wheels mounted individually on trailing arms and wishbones. The springs and shock absorbers have been individually adapted for the two 911 GT3 models to ensure precise wheel location, good directional stability and excellent handling.

The rear axle has subframe-mounted LSA (Light, Stable, Agile) multi-link suspension, as well as special shock absorber coordination. Ride height, camber, toe angle and anti-roll bar settings can be adapted individually for the racetrack. A special feature of the new 911 GT3 RS is that the wishbone on the rear axle is split. So camber can be adjusted even more precisely to the demands of motorsport.

Thanks to the very stiff connection between the chassis and body, there is more exact wheel location, so better handling and turn-in.

### Ride-height lift system.

Kerbs, ramps and garage entrances used to pose a problem for sports-cars like the 911 GT3 models. Not any more. Our engineers have

developed a new ride-height lift system for the front axle. The front of the vehicle can now be lifted by 30 mm if there is a risk of it grounding. A compressor generates air pressure that lifts the front shock absorbers in PASM (page 56).

The optional lift system is activated and deactivated by a button on the centre console\*. It can be

operated either while stationary or while travelling at a speed of up to approximately 50 km/h (31 mph).

\* The lift system should be moved to the lower position when the vehicle is parked because the air pressure is only maintained for a certain length of time.

911 GT3 front axle with Porsche Ceramic Composite Brake (PCCB)





### Steering.

Important for everyday use and essential on the racetrack: a steering system that responds to every steering command directly, with excellent precision and reliability. Just like the steering in the 911 GT3 models with variable steering ratio. For steering inputs around the straight-ahead position, such as when driving on the

motorway, the ratio is less direct – although still extremely agile with excellent feedback. The greater the steering input the more direct – and therefore more agile – the steering ratio. This is particularly beneficial on tight bends.

### Wheels and tyres.

The 911 GT3 models run on one-piece 19-inch GT3 wheels. They are painted titanium-colour on the 911 GT3 and a contrasting colour on the new 911 GT3 RS. Taken directly from motorsport is the central locking device with 'GT3' or 'RS' logo. The advantages over a conventional five-hole screwed fitting include better driving



dynamics and performance thanks to fewer rotating masses and, of course, faster wheel changes. A huge advantage – especially when racing.

The wheel dimensions on the 911 GT3 are 8.5 J x 19 with 235/35 ZR 19 tyres (front) and 12 J x 19 with 305/30 ZR 19 tyres (rear). Those on the new 911 GT3 RS are even more impressive: 9 J x 19 with 245/35 ZR 19 tyres (front) and 12 J x 19 with 325/30 ZR 19 tyres (rear). Road-legal sport tyres

provide the necessary grip for the 911 GT3 models, although the lower tread profile presents a greater risk of aquaplaning on wet roads.

The standard Tyre Pressure Monitoring (TPM) gives a warning, through the display on the on-board computer, before the tyre pressure becomes too low in the case of either a slow or very sudden loss of pressure.



19-inch GT3 wheel with central locking device (911 GT3)



19-inch GT3 wheel with central locking device in Guards Red contrasting colour (911 GT3 RS)



**A real paradox:  
The lower the intervention, the more dynamic the drive.**

### **Porsche Stability Management (PSM).**

To contribute towards safety and driving stability within the dynamic range, the 911 GT3 and new 911 GT3 RS are fitted for the first time with Porsche Stability Management (PSM). In addition to the anti-lock braking system (ABS), it includes two automatic control systems: Stability Control (SC) and Traction Control (TC).

Stability Control (SC) stabilises the lateral dynamics using sensors which constantly monitor the vehicle's speed, yaw velocity and lateral acceleration. From this information it is possible to calculate the actual direction of travel. If the vehicle deviates from its course, Stability Control (SC) might initiate selective braking on

individual wheels to stabilise the vehicle within the limits of its driving dynamics.

Traction Control (TC), with its integrated automatic brake differential (ABD), anti-slip regulation (ASR) and engine drag-torque control (EDC), regulates the longitudinal dynamics of the car. This sports-

oriented traction control improves handling when accelerating on different road surfaces. It also prevents the rear of the car from oversteering if a wheel loses traction under full power. However, the intervention threshold is relatively high, which means that it is rarely employed in normal dry conditions.

A unique feature of PSM on the 911 GT3 models is that the control interventions of both systems are delayed and can be disabled completely in two stages. This enables greater driver involvement, for example, when on the racetrack. Stage 1 disables the Stability Control (SC) via the 'SC OFF' switch in the centre console. In 'SC OFF' mode, the system does not intervene if the car goes off-course in the lateral direction. In addition to specific steering move-

ments, the vehicle can now also be controlled with the throttle to drive very dynamically around bends. Traction Control (TC) is still active in this mode.

Stage 2 disables Traction Control as well via the separate 'SC+TC OFF' switch. In this mode both lateral dynamic control and the traction control functions are deactivated. The driver now has full command of the vehicle.

In both stage 1 (SC OFF) and stage 2 (SC + TC OFF), the lateral dynamic control is not reactivated again even when there is hard braking within the ABS range. This strategy enables motorsport-derived dynamics for personalised performance on the racetrack. Compared to the 911 GT3, the PSM in the new 911 GT3 RS is set for even higher performance.

The anti-lock braking system integrated in PSM (ABS 8.0) remains active in all of these settings. ABS ensures that the braking distance is as short as possible for greater safety.



## Normal mode? A very subjective question.

### Porsche Active Suspension Management (PASM).

Both 911 GT3 models have Porsche Active Suspension Management (PASM), an electronic damper adjustment system, fitted as standard. PASM actively and continuously controls the individual damping forces for each wheel according to current road

conditions and driving style. Both models are also 30 mm lower than the standard 911 Carrera. At the press of a button, the driver can choose between two setup modes. 'Normal' mode is designed for sporty driving on general roads

and on the racetrack in wet conditions. 'Sport' mode is especially for maximum lateral acceleration and the best possible traction on the racetrack.



Left: Rebound in 'Normal' mode – damper piston and bypass valve

Right: Rebound in 'Sport' mode – damper piston only

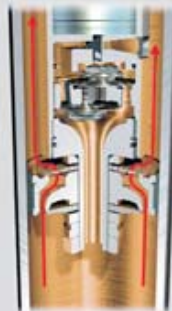

Left: Compression in 'Normal' mode – damper piston and bypass valve

Right: Compression in 'Sport' mode – damper piston only

Depending on which mode is set, and the road conditions detected, the system automatically selects the best damper application within the two setup ranges.

A range of sensors monitor the movement of the body during acceleration and braking or on uneven surfaces. The PASM control unit then specifically adjusts the damping force, depending which mode is

selected. Pitch and roll are reduced and the road contact of each individual wheel is optimised.

In 'Sport' mode the suspension is automatically set to a harder rating specially designed for use on the racetrack. The system will detect any unevenness on the surface and then, to improve road contact, it switches within a few milliseconds to a softer rating within the sport or stiff set-up range. When the track surface becomes even again, PASM returns to the original harder rating.

In 'Normal' mode, if the driving style becomes more dynamic, the system automatically switches to a sports-oriented rating within the normal set-up range. The suspension becomes stiffer so that driving stability and safety are increased.

## Safety

A high level of power calls for a high level of safety.  
And greater demands call for greater competence.







Bi-Xenon headlights and LED position lights

**Seeing and being seen.  
And always being seen in the right light.**

**Active safety.**

**Lighting.**

Fitted as standard on the 911 GT3 models are Bi-Xenon headlights with dynamic range control. These are around twice as bright as conventional halogen lights. With dipped or main beam, the lights are stronger

and more uniform, helping to minimise driver fatigue. A headlight cleaning system is built in.

For consistent use on the race-track, lightweight halogen headlights without integrated cleaning or range control are available as a no-cost option.

The front light units incorporate the direction indicators, the LED daytime running lights and position lights, which provide outstanding visibility and create an imposing look.

LEDs are also used for the rear direction indicators, taillights and brake lights, the additional brake light in the rear lid and the rear fog lights. These provide better illumination and respond more quickly to driver input so that following traffic is alerted earlier. They are energy efficient, eco-friendly and have a longer service life than conventional bulbs – as well as an unmistakable design, day or night.

**Dynamic cornering lights.**

Available as an option, dynamic cornering lights provide particularly effective illumination of the road. Sensors permanently monitor the speed, lateral acceleration and steering lock and, from these variables, calculate the course of the bend.

This determines the angle of the dynamic cornering lights, with dipped beams able to swivel outwards up to 15 degrees. So the course of the road and any obstacles can be identified much sooner, particularly during corners.

LED rear lights and third brake light



## Brakes.

Porsche brakes are renowned for their high level of efficiency. They set the benchmark for deceleration and stability and are designed for extreme conditions.

The new 911 GT3 RS and the 911 GT3 have a particularly powerful yet lightweight braking system with a specially adapted booster. The red-painted six-piston aluminium monobloc calipers on the front axle and the four-piston units at the rear provide a high level of rigidity and a consistent bite point, even under heavy braking.

The composite brake discs are large, with a diameter of 380 mm at the front and 350 mm at the back. Thanks to their two-piece design with newly developed standard brake discs and aluminium monobloc calipers, the weight is reduced and therefore the unsprung and rotating masses.



They are cross-drilled and internally vented for optimum performance in the wet.

Brake spoiler elements on the front axle, plus the new brake ducts on the rear ensure that the braking system is effectively ventilated.

Also designed for high performance is the four-channel anti-lock braking system (ABS 8.0) which is fast and precise, ensuring consistent deceleration and excellent overall brake performance.





### **Porsche Ceramic Composite Brake (PCCB).**

Optional for the 911 GT3 and the new 911 GT3 RS is brake technology that has already had to withstand the harshest requirements of motorsport: the Porsche Ceramic Composite Brake (PCCB).

To enhance braking performance, the ceramic composite brake discs in PCCB have a diameter of 380 mm at the front and 350 mm at the back. They are

made from a specially treated carbon-fibre compound that is silicated in a high-vacuum process at around 1,700 °C. The resulting brake discs are much harder and more resistant to heat than standard discs.

PCCB is characterised by its low thermal expansion which prevents deformation under heavy braking. Furthermore, the ceramic brake discs are totally resistant to corrosion and offer better noise-damping properties.

The use of six-piston aluminium monobloc brake calipers at the front and four-piston units at the rear ensures extremely high brake forces which, crucially, are exceptionally consistent. The pedal response is fast and precise with only moderate input required.

All the prerequisites are there for a short braking distance, even in the toughest conditions. Moreover, safety when braking from high speeds is increased thanks to PCCB's excellent fade resistance.

The key advantage of PCCB is the extremely low weight of the brake discs which are about 50 % lighter than standard discs of similar design and size. In addition, the monobloc calipers for the 911 GT3 models on the front and rear axle are made from aluminium, saving around 4.8 kg per vehicle compared to standard calipers. These factors not only have an impact on performance and fuel consumption, but also reduce unsprung and rotating masses.

The result: better road-holding and increased comfort, especially on uneven roads, as well as greater agility and even better handling.

Please note that circuit racing or other forms of performance driving can significantly reduce the service life of even the most durable brake pads and discs. As with conventional high-performance braking systems, we recommend that all brake

components be professionally inspected and replaced where necessary after every track event.

## It is important that the structure is well prepared too.

### Passive safety.

#### Bodyshell structure.

The reinforced bodyshell structure of the 911 GT3 models offers exceptional crash protection and an extremely resilient passenger cell. This protection is well within the statutory limits required by legislation for front, side and rear impact.

At the front of the car, longitudinal and transverse members (1) distribute the forces from an impact and minimise deformation of the passenger cell. A patented Porsche superstructure with a highly rigid bulkhead cross-member (2) made from super high-strength steel also absorbs

the forces from the front longitudinal members to protect both footwells. The reinforced doors (3) help increase the overall rigidity of the vehicle. In a frontal impact, this upper load path (4) helps to channel energy into the side structure and thus further protect the passenger cell. In the event of a

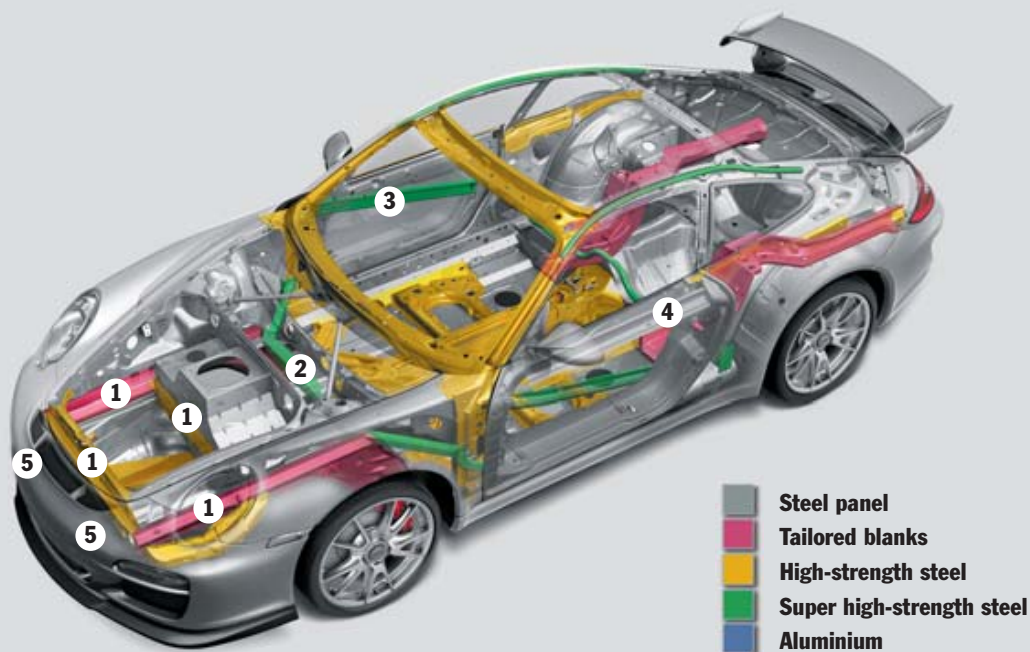

minor collision, a system of easily replaceable impact absorbers (5) prevents more serious damage.

#### Driver and passenger airbags.

Both full-size airbags inflate in two stages, depending on the severity of the impact. In a low-speed collision, the airbag is only partially inflated, thereby reducing occupant discomfort.

#### Porsche Side Impact Protection System (POSIP).

POSIP comes as standard and consists of side impact protection beams in each of the doors and side head airbags for each front seat. In addition, thorax airbags are located in the sides of the sports seats and head airbags in the door panels. With a volume of around eight litres each, these provide a high level of protection

in side impacts. Additional safety features are the headrests integrated in the backrest, a safety steering column, three-point seat belts with height adjustment, seat belt pre-tensioners and force limiters and energy-absorbing elements in the dashboard.



## High-performance sport requires professional equipment.

### Clubsport package.

The demands of motorsport are much higher than those of everyday use, on the materials, the equipment – and especially on the driver. At the racetrack,

low circuit times are what count. This extreme performance requires not only a high level of driver ability but also additional protection.

This protection is provided by the Clubsport package that is available for the 911 GT3 as a no-cost option and is standard for the 911 GT3 RS.

911 GT3 Clubsport package



911 GT3 RS Clubsport package



It consists of a roll cage that is bolted to the body behind the front seats, a six-point racing harness in red for the driver's side, a fire extinguisher with mounting bracket and preparation for a battery master switch.

The battery master switch and a front roll cage element are available from the Porsche Motorsport Department.

For the 911 GT3, the Clubsport package is available only in conjunction with the optional lightweight or sports bucket seats.

In the new 911 GT3 RS the sports bucket seats are fitted as standard. Exclusive to the new 911 GT3 RS is the red 'RS 3.8' logo on the headrests of the

sports bucket seats and optional lightweight bucket seats.

In conjunction with the Clubsport package, the seats are covered in a special flame-retardant fabric for extra safety.



## Comfort

Uncompromising on the racetrack.  
Forgiving in everyday use.





911 GT3 RS instrument panel

## From the very heart.

### Interior.

The interior of the 911 GT3 models clearly reflects their motorsport origins. Everything is designed around the driver to be within easy reach and clearly visible.

In the new 911 GT3 RS its direct connection with motorsport can be seen as soon as you open the

doors. In order to save weight, it is fitted with special lightweight door panels with red door pulls. Another difference from the 911 GT3 is the 'RS 3.8' logo on the door sill guards, the carpet at the back and on the decorative carbon-fibre hub cap on the dashboard.

### Instruments.

All essential information is displayed quickly and accurately on the five round instrument dials. The rev counter with GT3 logo and titanium-coloured dial face has a range that extends beyond 8,500 rpm. All instrument needles and dial

markings are in yellow for easy visibility. The upshift display in the rev counter shows the latest point to shift up for optimum acceleration.

### On-board computer.

The on-board computer provides information on average fuel consumption, speed, range till empty and external temperature. The data from the standard Tyre

Pressure Monitoring (TPM) system can also be viewed, as can the timing system featured in the optional Chrono Package or Chrono Package Plus.

### Interior materials.

More than anything else, the 911 GT3 models' sporting credentials are reflected in the two high quality materials used in the interior: genuine leather and Alcantara. The

benefits of Alcantara include exceptional grip and easy-care properties. It is therefore used wherever direct contact is required, such as on the steering wheel rim and on the gear and handbrake levers. In the 911 GT3 it is also used on the door storage compartments and on the door release levers.

### Steering wheel.

The three-spoke GT3 steering wheel has an Alcantara rim and manual height and reach adjustment. The airbag module has a leather finish and the three spokes have a vulcanised grey trim. A three-spoke sports steering wheel in smooth leather is available as a no-cost option. Exclusive to the standard steering wheel in the new 911 GT3 RS is the top centre marking on the steering wheel rim.

### Sports seats.

The standard sports seats in the 911 GT3 feature an integral thorax airbag in the outer backrest side bolster and are firmly upholstered to provide excellent support. The seat centres are in Alcantara, with the sides in leather. The fore/aft position and height are adjusted manually while the backrest angle has electric adjustment.

### Adaptive sports seats.

This alternative seat option for the 911 GT3 has electric adjustment of the fore/aft position, height and backrest angle. The side supports and backrest can be adjusted individually. For precision support when cornering on the track, as well as greater comfort on long-distance journeys.

### Sports bucket seats.\*

Optional for the 911 GT3 and standard in the new 911 GT3 RS are the sports bucket seats with folding backrest, integrated thorax airbag and manual adjustment of the fore/aft position. The seat shell is made from glass/carbon-fibre-reinforced plastic with a carbon-weave finish. The backrest pivots are positioned high in the side bolsters to provide characteristic lateral support in the lumbar area. In the 911 GT3 the standard trim is black leather with an Alcantara centre. Standard in the new 911 GT3 RS and the 911 GT3 in conjunction with the Clubsport package, the sports bucket seats

are covered in flame-retardant fabric. A fine detail in the new 911 GT3 RS is the red 'RS 3.8' logo on the headrests.

### Lightweight bucket seats.\*

Also available as an option for the new 911 GT3 are lightweight carbon-fibre bucket seats. They are designed to provide exceptional side support with minimal weight. Instead of a thorax airbag, the door panels are padded in place of the door storage compartment. Together the lightweight bucket seats weigh around 20 kg and are therefore almost 24 kg lighter than the sports seats and approximately 10 kg lighter than the sports bucket seats. In conjunction with the Clubsport package, the lightweight bucket seats are covered in flame-retardant fabric. A special feature in the new 911 GT3 RS is the red 'RS 3.8' logo on the headrests.

### HomeLink®.

This optional garage door opener is freely programmable and integrated into the overhead console. It remotely controls up to three different garage doors, gates, home lighting and/or alarm systems.

### Cruise control.

An automatic speed controller for the 30–240 km/h (20–149 mph) speed range is available as an option.

### Anti-theft protection.

The 911 GT3 models are equipped with an immobiliser with in-key transponder and an alarm system with contact-sensitive exterior protection and radar-based interior surveillance as standard.

### Vehicle tracking system.

The new 911 GT3 can also be equipped with an optional factory-fitted preparation enabling future installation of a vehicle tracking system available from Porsche Tequipment. This system enables a stolen vehicle to be located throughout most of Europe.

### 90-litre tank.

On request, for no extra charge, the standard 67-litre tank can be replaced with a 90-litre fuel tank to allow the car to cover longer distances before refuelling.

### The lithium-ion battery.\*\*

As an option for the 911 GT3 models, instead of the conventional battery a lithium-ion battery is available. Its main advantage is the approximately 10 kg weight saving compared to that of a conventional standard battery. The lithium-ion battery is included with the car and can be easily substituted for the standard battery for use on the racetrack.

Sports seat



Adaptive sports seat



Sports bucket seat folded down



Lightweight bucket seat



\* Child seats must not be used in conjunction with the sports bucket seats or lightweight bucket seats.

\*\* The battery has a limited cold-start function at temperatures below freezing.





Porsche Communication Management (PCM)

### PCM including navigation module.

On request, the 911 GT3 models can be fitted with Porsche Communication Management (PCM). As an efficient central information and communication system, it has an impressive range of functions but is surprisingly easy to use.

The main feature is the 6.5-inch colour touchscreen with a durable, easy-to-clean coating. It is functional, innovative and has a clear display – a maximum of five list entries per page make it quick and safe to use. You can also choose to operate PCM with the button controls.

Radio functions include up to 42 memory presets and an FM dual-tuner frequency diversity with RDS which constantly scans for the best signal for the selected station. The integrated single CD/DVD drive supports MP3 format. An integrated six-disc CD/DVD autochanger is also available for PCM as an option.

The GPS navigation module incorporated in PCM has an internal hard drive with map data for most European countries, allowing for fast route calculation, always with a choice of three alternative routes.

When viewing a map it is possible to select either a 3D perspective or a 2D display, which now also shows height profiles. At motorway exits, graphical turn indications are displayed for better orientation. In splitscreen mode you can choose to display not only the current map overview, but also a list of icons that represent dynamic route guidance.

### CDR-30 audio system.

The 911 GT3 and the new 911 GT3 RS are equipped as standard with the CDR-30 audio system with a 5-inch display (monochrome) and MP3-compatible CD player. An integrated six-disc CD autochanger is available as an option.

The FM dual tuner with RDS diversity, a total of 30 memory presets, dynamic autostore and speed-sensitive volume control are, as usual, part of the standard package. Just like the high-quality sound, which is delivered by four loudspeakers and an integrated amplifier with 2 x 25-Watt power.

### Sound Package Plus.

For discerning ears, the Sound Package Plus is available as an option. Nine high-quality loudspeakers and an external amplifier with a total output of 235 Watts provide a sound experience that is in perfect harmony with the interior space.

Sound settings can be customised using the CDR-30 audio system or the optional Porsche Communication Management (PCM).

CDR-30 audio system



**Electronic logbook for PCM.**

The optional electronic logbook allows automatic recording of mileage, route distance, date and time, starting point and destination as part of every journey.

**Voice control system for PCM.**

Almost all of the functions of PCM can be controlled using the optional voice control system. Each menu item is read aloud exactly as it is displayed on the screen and the voice control system recognises the commands or number sequences, irrespective of the speaker. It gives audible feedback and guides you through the functions. There is no need to 'train' the system. Phone book entries can be retrieved, a radio station selected or the navigation destination entered directly by speaking whole words.

**Telephone module for PCM.**

The optional quadband GSM telephone module offers convenience and excellent reception. By inserting your SIM card directly into PCM's integrated SIM card reader, calls can be made using either the hands-free facility or the optional Bluetooth® handset. For even more convenience, the Bluetooth® capability of a mobile phone can be used to make calls via the SIM Access Profile (SAP).\* Once automatic pairing is complete, the mobile phone's aerial is switched off to conserve battery charge and the phone operates via the car aerial. Depending on the mobile phone model, this gives access not only to the numbers on the SIM card but also to the phone's internal memory. Also, depending on the phone, it can be controlled using PCM or the voice control system, without ever leaving your pocket.

**Mobile phone preparation for PCM and CDR-30.**

A mobile phone preparation kit is available on request for Bluetooth® connection of mobile phones which only support the Handsfree Profile (HFP)\*. For connection by HFP, PCM or CDR-30 acts merely as a hands-free system. Here, too, the mobile phone can remain tucked away. Only the basic phone functions can be operated using PCM or CDR-30. The GSM connection is established via the aerial of the mobile phone\*\*. The mobile phone preparation kit is available with or without cradle.

**Universal audio interface for PCM and CDR-30.**

In conjunction with PCM, you can have, as an option, up to three connections for your iPod®, a USB stick/MP3 player or any audio source as an AUX interface. The iPod® or a USB stick can be operated conveniently and safely via PCM. The USB connection can also be used to download data from the performance display of the Chrono Package Plus or the electronic logbook. In conjunction with the standard CDR-30 radio, you can use any audio source via an AUX connection. In this case, you use the controls on the device itself.

**Chrono Package for CDR-30.**

A useful option when driving the 911 GT3 models on the racetrack, the Chrono Package is available for the CDR-30 audio system and includes a swivelling, dashboard-mounted analogue and digital timer. It is operated via the steering column stalk for the on-board computer. The analogue display shows the elapsed hours, minutes and seconds. Seconds, tenths of seconds and hundredths of seconds appear on one display, while at the same time there is a digital display on the instrument cluster.

**Chrono Package Plus for PCM.**

The Chrono Package Plus option is only available in conjunction with PCM. The system combines an analogue and digital timer unit with a range of useful functions. Lap or journey times can be viewed, stored and analysed using the performance display in PCM. The driver can use it to find out the time and distance travelled on the current lap, as well as the number of laps completed and their respective times. The fastest lap and remaining range till empty can also be viewed. Any section of road can be recorded, as well as benchmark sections. The Chrono Package Plus personal memory function, also controlled via PCM, stores personal settings for lights, wipers, air conditioning and door locks.

\*/\*\* See information on pages 105/106.

Chrono timer unit







## Motorsport

At some time everyone goes back to their roots.  
Or they never leave them in the first place.



**GT sport.**

GT vehicles are also pure-bred race cars. However, these must be based on a road-legal sports car, only parts of which may be modified.

In 2009, Porsche will be represented on the starting line by the 911 GT3 RSR. Its 4.0-litre Boxer engine delivers 450 hp and a maximum torque of 430 Nm. Porsche builds the race-ready

vehicles and supports customer teams through development and technical service and by supplying works drivers.

With its overall win in the 24 Hours of Nürburgring and class wins in the ALMS, LMS and the FIA-GT, the 2009 season was a victorious one for the 911 GT3 RSR, enabling it to add to the numerous successes of the past. In short, whether in the 24 hours of Le Mans, in the ALMS/LMS,

the FIA-GT or in national GT championships, Porsche private teams are regularly driving to win races and championships.

More information is available at [www.porsche.com/motorsport](http://www.porsche.com/motorsport).

**Origins: motorsport.**

**Where our inner self comes to life.**

**Prototype sport.**

Prototypes are pure-bred race cars that are not based on road-legal production sports cars. For example, the RS Spyder, built to LMP2 (Le Mans Prototype 2) requirements. In 2009 – after the stipulated reduction of the air restrictor - its 3.4-litre V8 racing

engine delivered 440 hp. The total vehicle concept is based on a low centre of gravity, excellent traction and a low weight. The result is an impressive success story.

Out of 42 races driven, by the middle of 2009, the RS Spyder had achieved a total of 32 class wins and 11 overall victories.

Thanks to this success, Porsche won the drivers, team and constructors championships in the ALMS and the European LMS. In addition to this, Porsche was overall winner of the 12 Hours of Sebring and had two class winners in the 24 Hours of Le Mans.







Porsche Mobil 1 Supercup

### Porsche Cups.

There are seven Porsche Carrera Cup championships throughout the world – with races in 15 countries, from Japan to France – and internationally the fastest one-make championship, the Porsche Mobil 1 Supercup.

The philosophy behind these races is that all competitors have an equal chance, so all the vehicles are technically identical. 911 GT3 Cup vehicles, direct descendants of the 911 GT3, producing 420 hp and 285 km/h (177 mph), take part in sprint races in leading international race events. The result is hard-fought, exciting international competitions at the highest level.

For all Porsche Cups, Porsche supplies the customer teams with ready-to-use racing cars, organises the race series and looks after the drivers, teams and sponsors at the events.

### Porsche Mobil 1 Supercup.

The Porsche Mobil 1 Supercup is the world's fastest international one-make championship. It is held exclusively as part of the FIA Formula 1 World Championship in Bahrain and in Turkey, as well as at the European Grand Prix races. A total of 11 races are held, each with an average of 120,000 spectators.

For more information, call +49 (0)711 911-84096 or [www.porsche.com/motorsport](http://www.porsche.com/motorsport).

### Porsche Carrera Cup Deutschland.

The Porsche Carrera Cup Deutschland premiered in 1990 and has developed into one of the fastest national one-make championships in the world.

It is an established part of the German Touring Car Masters (DTM) calendar. This series of races inspires not only the highest sporting performance, but also an extremely attractive programme of events. Each season has nine qualifying rounds in Germany and other neighbouring countries.

For more information, call +49 (0)711 911-84041 or visit [www.porsche.com/motorsport](http://www.porsche.com/motorsport).

Porsche Carrera Cup Deutschland



### **Porsche Sport Driving School.**

Training is given by experienced Porsche instructors on a range of courses, from beginner to advanced, including final preparation for a racing licence. Customers can use their own car or a loan vehicle supplied by Porsche. Courses take place on and off-road and are held at national and international race

circuits, as well as Porsche's own track in Leipzig, so that the foundation is laid for the next stage – the Porsche Sports Cup.

For more information, call +49 (0)711 911-78683 or visit [www.porsche.com/motorsport](http://www.porsche.com/motorsport).

### **Porsche Sports Cup.**

Five racetracks, six events, one experience: the Porsche Sports Cup. Including races for both road-licensed and race-modified Porsche vehicles, these events are held on tracks such as the Nürburgring or Spa-Francorchamps.

From 2009, Porsche Sports Cup events will be even more exciting with the introduction of a new

Porsche Sport Driving School



Porsche Sports Cup

series: the GT3 Cup Challenge. This will provide a link to the Porsche Carrera Cup and will be the first championship of its kind in Europe.

For more information call +49 (0) 711 911-12384 or visit [www.porchesportscup.de](http://www.porchesportscup.de)

### **Porsche Clubsport.**

The privately run Porsche Club network organises individual competitions and series in which drivers compete in different classes. The first Porsche Club was founded by a small group of enthusiasts back in 1952. Today there are 613 clubs in over 60 countries worldwide

with around 120,000 members – and the trend is growing. The Porsche Club organisation is therefore one of the largest and longest-established automotive bodies in the world.

For more information, call +49 (0) 711 911-78307 or visit [www.porsche.com](http://www.porsche.com).





### Customer service at the racetrack.

We can provide specialist advice on setting up your new 911 GT3 Cup vehicle to suit individual circuits. This includes changes to the gear ratios and aerodynamics and the various suspension setup options. In the event of technical problems during a race, you can count on our advice. At selected

endurance events, you can even request your own dedicated team of Porsche mechanics. We also stock a full range of parts which are not subject to normal wear.

For more information, visit [www.porsche.com/motorsport](http://www.porsche.com/motorsport).

### Porsche Motorsport customer service.

We want to offer our motorsport customers more than the finest race cars in the world. So you are not only in the best company in our cars, but with us as well. For pure-bred race cars such as the 911 GT3 Cup, Porsche offers customer service that provides specialist support in Weissach as well as trackside anywhere in the world.

### Customer service in Weissach.

Your new 911 GT3 model can be ordered direct from your Porsche Centre. Race-only cars, such as the 911 GT3 Cup, are exclusively available from the Special and Racing Vehicle Department at the Porsche R&D Centre in Weissach. We can also provide you with specialist technical assistance for both national and international competition. From vehicle setup to your own personal specification

to modifications to your Porsche, our Motorsport department can offer all the technical support that you or your team require.

And that's not all: we can also supply parts, kits and accessories for your Porsche as well as expert advice on racing regulations – even for classic Porsche vehicles.

For more information, visit [www.porsche.com/motorsport](http://www.porsche.com/motorsport).



## Environment

It's about every hundredth of a second.  
But not at any price.







**It's all about efficiency.**

**And the relationship with the environment.**

In an era of intensifying debate about CO<sub>2</sub> emissions, every automotive manufacturer is being asked the question, 'What is your answer to the issue of fuel consumption?' Our answer has long been the same: maximum efficiency.

Over the last 15 years, Porsche has been reducing the CO<sub>2</sub> emis-

sions of its vehicles annually by an average of around 1.7%. In relation to engine power, Porsche is already among those manufacturers achieving the lowest CO<sub>2</sub> emissions. This has been achieved through a new efficient drive concept, optimum aerodynamics, low rolling resistance and lightweight construction. This high level of environmental responsibility

is demonstrated by our approach to environmental management at the Porsche development centre in Weissach. Here, all technological developments are carried out with environmental protection in mind. The objective is to achieve pure performance, but not at the expense of the environment.

**Exhaust emission control.**

The 911 GT3 and the new 911 GT3 RS comply with stringent emissions standards, including Euro 5 in Europe and LEV II in the USA. Porsche vehicles demonstrate that even high-performance sports cars can achieve moderate emission values in their respective category. The 911 GT3 models are not only amongst the most powerful sports cars, but they are also amongst the cleanest.

This is achieved using two catalytic converters and an oxygen-sensor control system. The two banks of cylinders are monitored separately. Two corresponding oxygen sensors control the exhaust gas composition individually for each exhaust section. In addition to this, another sensor for each bank of cylinders monitors the conversion of pollutants in each catalytic converter.\*

\* Except in countries with leaded petrol.

**Fuel.**

Today's Porsche sports cars are already designed to run on 10% ethanol. Ethanol has a positive impact on the CO<sub>2</sub> balance since the plants grown for the production of this biofuel also absorb CO<sub>2</sub> from the atmosphere.

**Fuel system.**

In the fuel system of the 911 GT3 models, the emission of hydrocarbons has been minimised. This is achieved through a large active carbon filter and a special coating on the fuel tank. All pipes that carry fuel are made from aluminium, while vapour-carrying lines are made from multi-layered plastic.

**Noise.**

The 911 GT3 models comply with all valid noise requirements in the countries where they are sold. Noises are eliminated at source. It sounds paradoxical, but without any noise there is only one pure sound.

**Servicing.**

Long service intervals offer clear advantages. For you: lower costs and saved time. For the environment: the use of fewer consumables and replacement parts. For details of the service intervals for the 911 GT3 models, please refer to the separate price list.

## Personalisation

There are many ways to enhance its character.  
Enhance yours.

**The bright colours are not just in the grandstands. Colours.**

For your new 911 GT3, you have a choice of four solid colours and, as an optional extra, six metallic and seven special colours. The interior is available in standard black trim, optional black leather and optional Dark Grey natural leather.

The 911 GT3 RS comes in Carrara White and Aqua Blue Metallic as standard and Grey Black is available as an option. These colours can be combined with the contrasting colours Guards Red or White Gold Metallic. A striking feature are the new logos on the front right and back left wings. The interior of the new 911 GT3 RS is in black.

To see how the available colours would look on your car, visit [www.porsche.com](http://www.porsche.com) and use the online Porsche Car Configurator.



911 GT3 RS: Grey Black exterior colour with White Gold Metallic contrasting colour



911 GT3 RS: Aqua Blue Metallic exterior colour with Guards Red contrasting colour



911 GT3 RS: Carrara White exterior colour with Guards Red contrasting colour



**Colours 911 GT3.**

**Solid exterior colours.**

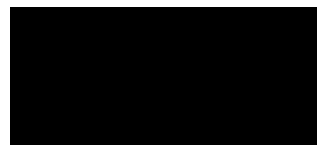

Black



Guards Red

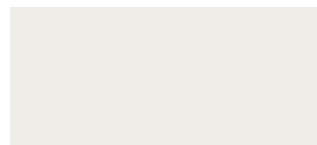

Carrara White



Speed Yellow

**Metallic exterior colours.**



Basalt Black Metallic

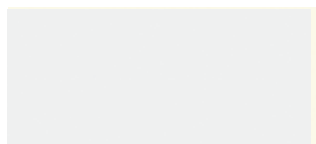

Arctic Silver Metallic



Aqua Blue Metallic



Macadamia Metallic



Meteor Grey Metallic



Dark Blue Metallic\*

**Special exterior colours.**



Cream White



GT Silver Metallic



Porsche Racing Green Metallic

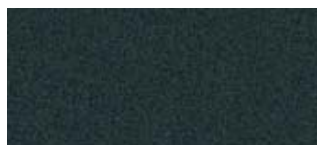

Atlas Grey Metallic



Nordic Gold Metallic



Ruby Red Metallic



Malachite Green Metallic

**Standard interior colours.  
Leatherette/leather/ Alcantara.**



Black

**Natural leather/Alcantara interior.**

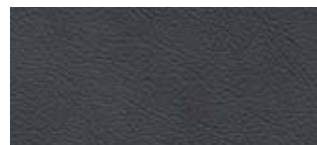

Dark Grey

**911 GT3 RS colours.**

**Exterior standard colours/  
contrasting colours\*.**



Carrara White

Guards Red

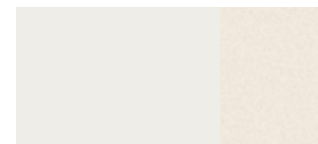

Carrara White

White Gold Metallic



Aqua Blue Metallic

Guards Red



Aqua Blue Metallic

White Gold Metallic

**Interior standard colour.  
Leatherette/Leather/Alcantara.**



Black

**Exterior optional colours/  
contrasting colours\*.**



Grey Black

Guards Red



Grey Black

White Gold Metallic

**Roll-over bar.**



Guards Red

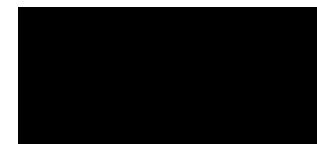

Black



Guards Red

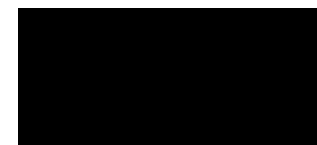

Black

\*Introduction planned for 10/2009.

\*Exterior contrasting colour includes: wheels, front air intake grille surround, rear wing side plates, exterior mirrors, vinyl decal on side and front right and rear left wing and 'GT3 RS' logo on the engine cover



Rear lights with clear glass look



Lightweight headlights

Porsche Ceramic Composite Brake (PCCB)



Wheels painted silver



**Option**

**911 GT3**  
**911 GT3 RS**

**I no.** **Page**

**Exterior.**

• Metallic paint	○	•*	Code	97
• Special colours	○	○	Code	98, 99
• 90-litre fuel tank	w	w	082	
• Dynamic cornering lights	○	○	603	
• Lightweight headlights	w	w	600	100
• Lightweight battery (lithium-ion)**	○	○	191	75
• Rear lights with clear glass look***	○	○	XXG	100
• Grey top tint on windscreen	○	○	567	
• Automatically dimming interior/exterior mirrors with integrated rain sensor	○	–	P12	
• Deletion of model designation	w	–	498	

**Chassis.**

• Porsche Ceramic Composite Brake (PCCB)	○	○	450	64, 100
• Front axle ride-height lift system	○	○	474	51
• Dynamic engine mounts	○	•	140	48
• Wheels painted silver	w	w	346	100

\*Aqua Blue Metallic

\*\*Introduction planned for 01/2010.

\*\*\*Introduction planned for 10/2009.

○ extra-cost option    • standard equipment    W no-cost option    – not available

The vehicles pictured in the chapter on personalisation may include additional options not featured in this catalogue.

For information on these options, please consult your Porsche Centre.

For more information on the options featured in this catalogue, please refer to the separate price list.



Option	911 GT3	911 GT3 RS	I no.	Page
<b>Interior.</b>				
• Clubsport package Bolt-in roll-over bar at rear, preparation for battery master switch. Includes six-point racing harness in red for driver's side, fire extinguisher with mounting bracket. Only available in conjunction with sport bucket seats or lightweight seats	w	•	003	68, 103
• Six-point passenger seat belt, only in conjunction with Clubsport package	o	o	579	
• Deletion of Clubsport package	–	w	703	
• Deletion of air conditioning	–	w	574	
• Roll-over bar in black	–	w	595	
• Cupholder	•	w	585	
• HomeLink® (garage door opener)	o	o	608	75
• Cruise control	o	o	454	75
• Preparation for vehicle tracking system	o	o	674	75
• Adaptive sports seats	o	–	P01	74
• Sports bucket seats	o	•	P03	74, 103
• Lightweight bucket seats	o	o	P02	74, 75
• Heated seats. Only in conjunction with sports seats or adaptive sports seats	o	–	342	
• Fire extinguisher	o	•*	509	69, 103
• Floor mats with Porsche logo, set of two	o	o	810	

**Interior: leather.**

• Leather interior package in Black	o	o	Code	103
• Leather interior package in natural leather (Dark Grey)	o	–	998	
• Three-spoke sports steering wheel in smooth leather finish	w	w	841	

\* Different design: DIN-EN3 power fire extinguisher with 4 kg extinguishing agent included.  
 o extra-cost option    • standard equipment    W no-cost option    – not available  
 For more information on the options featured in this catalogue, please refer to the separate price list.



Clubsport package



Leather trim in black



Deletion of CDR-30 audio system

**Option**

	911 GT3	911 GT3 RS	I no.	Page
--	---------	------------	-------	------

**Audio and communication: CDR-30.**

• CDR-30 audio system	•	•		76
• Deletion of CDR-30 audio system	–	w	609	104
• Sound Package Plus	o	o	490	76
• Six-disc CD autochanger	o	o	692	
• Universal audio interface (AUX)	o	o	870	79, 104
• Mobile phone preparation */**	o	o	619	78
• Mobile phone preparation with cradle */**	o	o	618	78
• Chrono Package	o	o	639	79
• External aerial	w	w	461	

Cordless handset for telephone module



Universal audio interface



\* For information on compatible mobile phones, please contact your Porsche Centre or visit [www.porsche.com](http://www.porsche.com).

\*\* Mobile phone preparation: The use of a mobile phone inside a vehicle may cause an increase in the interior electromagnetic field strength and, accordingly, in the electromagnetic radiation to which passengers are exposed. If a cradle is used to mount the mobile phone, the field strength inside the vehicle can be reduced by connecting to the exterior aerial (depending on how specific mobile phones connect to the cradle). For more information about the availability of a cradle for our mobile phone, please contact your Porsche Centre. Use of the telephone module for PCM prevents exposure to electromagnetic radiation as only the vehicle's external aerial is used.

o extra-cost option    • standard equipment    W no-cost option    – not available  
For more information on the options featured in this catalogue, please refer to the separate price list.



Option	911 GT3	911 GT3 RS	I no.	Page
<b>Audio and communication: PCM.</b>				
• PCM including navigation module, only with Sound Package Plus	o	o	P23	76, 77
• Sound Package Plus	o	o	490	76
• Six-disc CD/DVD autochanger	o	o	693	
• Universal audio interface (AUX, USB, iPod®)	o	o	870	79, 104
• Telephone module*	o	o	666	78
• Cordless handset for telephone module	o	–	669	104
• Mobile phone preparation**	o	o	619	78
• Mobile phone preparation with cradle**/**	o	o	618	78
• Electronic logbook	o	o	641	78
• Voice control system	o	o	671	78
• Chrono Package Plus	o	o	640	79
• External aerial	w	w	461	



## Porsche Exclusive

**State-of-the-art.  
And to your specification.**

With Porsche Exclusive you have the opportunity to make your Porsche even more special. Direct from the factory.

Individually and exclusively tailored, both aesthetically and technically, inside and out, using fine materials and with customary Porsche quality. The principle is customisation by hand. You will find a wide range of design options in the separate Exclusive 911 catalogue or visit [www.porsche.com](http://www.porsche.com).

Your Porsche Centre will be pleased to provide you with further information. Alternatively, you can contact the customer centre in Zuffenhausen on +49 (0)711 911-25977. Please note that delivery times may be extended for certain Porsche Exclusive equipment.

\* For information on compatible mobile phones, please contact your Porsche Centre or visit [www.porsche.com](http://www.porsche.com).  
 \*\* Mobile phone preparation: The use of a mobile phone inside a vehicle may cause an increase in the interior electromagnetic field strength and, accordingly, in the electromagnetic radiation to which passengers are exposed. If a cradle is used to mount the mobile phone, the field strength inside the vehicle can be reduced by connecting to the exterior aerial (depending on how specific mobile phones connect to the cradle). For more information about the availability of a cradle for our mobile phone, please contact your Porsche Centre. Use of the telephone module for PCM prevents exposure to electromagnetic radiation as only the vehicle's external aerial is used.  
 o extra-cost option    • standard equipment    W no-cost option    – not available  
 For more information on the options featured in this catalogue, please refer to the separate price list.



### Porsche Centres

Your Porsche Centre can assist you with every aspect of purchasing and owning your Porsche. You will also find a wide range of products and services, including genuine Porsche parts and accessories.

### Porsche Assistance

Enjoy peace of mind with our exclusive breakdown and accident recovery service. Membership is free when you buy a new Porsche.

### Porsche Financial Services

Our innovative suite of financial services is specially tailored to the needs of Porsche owners. Products range from attractive finance and leasing options to vehicle insurance and the Porsche Card.

### Porsche Exclusive

Realise your vision of the perfect Porsche with our factory customisation programme. From styling enhancements to performance upgrades, all modifications are uniquely handcrafted for your Porsche.

### Porsche Tequipment

Personalise your Porsche at any time after purchase with the Tequipment range of approved accessories. Designed exclusively for your car, every product is fully guaranteed.

### Porsche Design Driver's Selection

With products ranging from fashion and accessories to tailored luggage, this unique collection combines quality and style with everyday practicality.

## Service



### Porsche Online

For all the latest news and information from Porsche, go to [www.porsche.com](http://www.porsche.com).

### Porsche Used Car Programme

Porsche Approved is the simple way to find the perfect pre-owned Porsche, anywhere in the world. Every car is rigorously tested and comes with a comprehensive vehicle warranty.

### Porsche Classic

Your specialist source for genuine Porsche parts and technical documentation as well as servicing, repair and restoration for all types of classic Porsche. Find out more at [www.porsche.com/classic](http://www.porsche.com/classic).

### Christophorus

Our bi-monthly magazine for Porsche owners has news, interviews and a wide variety of features from throughout the world of Porsche.

### Porsche Clubs

Since the first Porsche Club was founded in 1952, their number has grown to 613 with a total of 120,000 members worldwide. To find out more, call +49 (0)711 911-78307 or go to [www.porsche.com](http://www.porsche.com).

### Porsche Driving Experience

**1. Porsche Travel Club.** Exclusive driving holidays and incentive ideas combining luxury and adventure, worldwide. To find out more, call +49 (0)711 911-78155. E-mail: [travel.club@porsche.de](mailto:travel.club@porsche.de)

### 2. Porsche Sport Driving School.

Develop your skill and explore your Porsche with the Porsche Sport Driving School. To learn about events at some of the world's most famous racing venues, call +49 (0)711 911-78683. E-mail: [sportdrivingschool@porsche.de](mailto:sportdrivingschool@porsche.de)



Ask your Porsche Centre for the latest brochures from Porsche Exclusive, Porsche Tequipment, Porsche Design Driver's Selection and the Porsche Driving Experience.



## Summary

The 911 GT3 and the new 911 GT3 RS. Developed by racing engineers using technology from the racetrack. With the ambition to drive what has been tried and tested to perfection. What you expected?

Nothing but the truth.



## Technical data

Engine	911 GT3	911 GT3 RS
Cylinders	6	6
Displacement	3.797 cm <sup>3</sup>	3.797 cm <sup>3</sup>
Max. power (DIN) at rpm	320 kW (435 hp) 7,600	331 kW (450 hp) 7,900
Max. torque at rpm	430 Nm 6,250	430 Nm 6,750
Compression ratio	12.0:1	12.2:1
<b>Transmission</b>		
Layout	Rear-wheel drive	Rear-wheel drive
Manual gearbox	6-speed	6-speed
<b>Chassis</b>		
Front axle	McPherson strut suspension	McPherson strut suspension
Rear axle	LSA multi-link suspension	LSA multi-link suspension
Steering	Power-assisted (hydraulic), with variable steering ratio	Power-assisted (hydraulic), with variable steering ratio
Turning circle	10.9 m	10.9 m
Brakes	Six-piston aluminium monobloc fixed calipers at front and four-piston aluminium monobloc fixed calipers at rear, composite brake discs internally vented and cross-drilled	Six-piston aluminium monobloc fixed calipers at front and four-piston aluminium monobloc fixed calipers at rear, composite brake discs internally vented and cross-drilled
Vehicle stability system	Porsche Stability Management (PSM)	Porsche Stability Management (PSM)
Anti-lock braking system	ABS 8.0 (incorporated in PSM)	ABS 8.0 (incorporated in PSM)
Wheels	Front: 8.5 J x 19 ET 53 Rear: 12 J x 19 ET 63	Front: 9 J x 19 ET 47 Rear: 12 J x 19 ET 48
Tyres	Front: 235/35 ZR 19 (sport tyres) Rear: 305/30 ZR 19 (sport tyres)	Front: 245/35 ZR 19 (sport tyres) Rear: 325/30 ZR 19 (sport tyres)

Weights*	911 GT3	911 GT3 RS
Unladen weight (DIN)	1,395 kg	1,370 kg
Unladen weight (EC)**	1,470 kg	1,445 kg
Permissible gross weight	1,680 kg	1,680 kg
<b>Performance*</b>		
Top speed	312 km/h (194 mph)	310 km/h (193 mph)
0–100 km/h (0–62 mph)	4.1 secs	4.0 secs
0–160 km/h (0–99 mph)	8.2 secs	8.1 secs
0–200 km/h (0–124 mph)	12.3 secs	12.2 secs
Flexibility (80–120 km/h) (50–75 mph) in 5th gear	5.8 secs	5.3 secs
<b>Fuel consumption/emissions***</b>		
Urban in l/100 km (mpg)	19.2 (14.7)	19.4 (14.6)
Extra urban in l/100 km (mpg)	9.0 (31.4)	9.6 (29.4)
Combined in l/100 km (mpg)	12.6 (22.4)	13.2 (21.4)
CO <sub>2</sub> emissions in g/km	298	314
<b>Dimensions/aerodynamics</b>		
Length	4,460 mm	4,460 mm
Width (with exterior mirrors)	1,808 mm (1,952 mm)	1,852 mm (1,952 mm)
Height	1,280 mm	1,280 mm
Wheelbase	2,355 mm	2,355 mm
Luggage compartment volume	105 litres	105 litres
Tank capacity (refill volume)	67 litres	67 litres
Drag coefficient	0.32	0.33
<p>* No officially verified values were available at the time of going to print. Please contact your Porsche Centre for the final and officially certified values.</p> <p>** Weight is calculated in accordance with the relevant EC Directives and is valid for vehicles with standard specification only. Optional equipment increases this figure. The figure given includes 68 kg for the driver and 7 kg for luggage.</p> <p>*** These data were obtained using the Euro 5 measurement method (715/2007/EC and 692/2008/EC) in the NEDC (New European Driving Cycle) with standard equipment. The information does not refer to an individual vehicle and is not part of the offer, but is simply provided so that comparisons can be made between different types of vehicle. Further, up to date information on the individual vehicles can be obtained from your Porsche Centre. Consumption figures were obtained on the basis of standard equipment. Special equipment may affect consumption and performance. 911 GT3 RS: Provisional figures as there were no official figures available at the time of going to print. Please contact your Porsche Centre for the final and officially certified values.</p>		



# Index

<b>A</b>		<b>D</b>		<b>I</b>		<b>P</b>		<b>R</b>		<b>T</b>	
Aerodynamics	12, 24	Design	12, 24	Instruments	72	Personalisation	94	Ram-air collectors	17	Technical data	112
Airbag	67	Drive	40	Intake manifold	38	Porsche Active Suspension Management (PASM)	56	Rear axle	50	Telephone module	78
Anti-theft protection	75	Dynamic cornering lights	61	Interior	72	Porsche Carrera Cup	85	Ride-height lift system	51	Traction Control	55
Audio interface, universal	79	Dynamic engine mounts	48	Interior materials	73	Porsche Ceramic Composite Brake (PCCB)	64	Roll-over bar	102	Transmission	40
Audio system, CDR-30	76					Porsche Clubsport	87			Tyre Pressure Monitoring (TPM)	53
		<b>E</b>		<b>L</b>		Porsche Communication Management (PCM)	77	<b>S</b>			
<b>B</b>		Electronic logbook	78	Leather	98, 102	Porsche Cups	84	Safety	58		
Bi-Xenon headlights	60	Environment	90	Lights	60	Porsche Mobil 1 Supercup	85	Seats		<b>U</b>	
Bodyshell structure	66	Exhaust system	39	Lightweight battery (lithium-ion)	75	Porsche Motorsport	80	Seats, lightweight bucket	75	Universal audio interface	79
Braking system	62	Exhaust emission control	93	Lightweight headlights	60, 100	Porsche Motorsport customer service	88	Seats, sports bucket	74		
		Single-mass flywheel	21, 40	Locking rear differential	29	Porsche Side Impact Protection System (POSIP)	67	Service	108	<b>V</b>	
				Lubrication, dry-sump	36	Porsche Sport Driving School	86	Servicing	93	VarioCam	36
<b>C</b>		<b>F</b>				Porsche Sports Cup	86	Six-cylinder Boxer engine	32	Vehicle tracking system	75
Catalytic converter	39, 93	Front axle	50			Porsche Stability Management (PSM)	54	Sound Package Plus	76	Voice control system	78
Chassis	46, 50	Fuel system	93	<b>N</b>		Prototype racing	82	Sport exhaust system	39		
Central locking device	10, 22, 52			Noise	93			Sports seats	74	<b>W</b>	
Chrono Package	79	<b>G</b>						Sport tyres	53	Wheels	52
Chrono Package Plus	79	Gearbox, manual	40	<b>O</b>				Stability Control	54		
Clubsport package	68	GT racing	83	Oil supply	33, 36			Steering	52		
Colours	97			On-board computer	73			Steering wheel	74		
Comfort	70	<b>H</b>		Oxygen-sensor control	27						
Cruise control	75	HomeLink®	75								

The models featured in this publication are approved for road use in Germany. Some items of equipment are available as extra-cost options only. The availability of models and options may vary from market to market due to local restrictions and regulations. For information on standard and optional equipment, please consult your Porsche Centre. All information regarding construction, features, design, performance, dimensions, weight, fuel consumption and running costs is correct at the time of going to print. Porsche reserves the right to alter specifications and other product information without prior notice. Colours may differ from those illustrated. Errors and omissions excepted.

© Dr. Ing. h.c. F. Porsche AG, 2009  
All text, images and other information in this publication are copyright of Dr. Ing. h.c. F. Porsche AG.

No part of this publication may be reproduced, transmitted, or otherwise used, without from the prior written consent of Dr. Ing. h.c. F. Porsche AG.

Porsche, the Porsche Crest, 911, Carrera, Tequipment, PCCB, PCM and PSM are registered trademarks of Dr. Ing. h.c. F. Porsche AG.

Dr. Ing. h.c. F. Porsche AG supports the use of paper from sustainable forestry. This catalogue is printed on paper made from 100% PEFC certified pulp (Programme for the Endorsement of Forest Certification).

Dr. Ing. h.c. F. Porsche AG  
Porscheplatz 1  
70435 Stuttgart  
Germany  
[www.porsche.com](http://www.porsche.com)

Edition: 09/09  
Printed in Germany  
WSLG1001000120 GB/WW



